



RX2102 model shown

HOBOMicroRX Station

Models: RX2101 MicroRX Station
 RX2102 MicroRX Station with Solar Panel
 RX2103 MicroRX Water Level Station
 RX2104 MicroRX Water Level Station with Solar Panel

Included Items:

- Grease packet
- Screws and washers
- Cable ties
- Six AA lithium batteries (RX2101 and RX2103 models)
- Rechargeable battery pack (RX2102 and RX2104 models)

Required Items:

- HOBOLink
- Smart Sensors (required for RX2101 and RX2102; optional for RX2103 and RX2104)

For RX2103 and RX2104 models:
 One MX2001 water level sensor and one cable:

- MX2001-01-S or MX2001-01-Ti-S (Titanium), 9-meter/30-foot depth
- MX2001-02-S, 30-meter/100-foot depth
- MX2001-03-S, 76-meter/250-foot depth
- MX2001-04-S or MX2001-04-Ti-S (Titanium), 4-meter/13-foot depth
- Cable (CABLE-RWL-xxx)

Optional Items:

- AC adapter (P-AC-1)
- Ground wire (CABLE-MICRO-G)
- 2-meter tripod (M-TPB)
- 3-meter tripod (M-TPA)
- 1.5 meter mast (M-MPB)
- 1-5/8 inch U-bolts (U-BOLT-KIT2)
- Guy wire kit (M-GWA)
- 1/2 inch stake kit (M-SKA)
- Well cap (WELL-CAP-02)

Smart sensors and accessories are available at www.onsetcomp.com.

The HOBOMicroRX Station provides continuous logging for a broad range of weather monitoring and microclimate applications with up to five plug-and-play smart sensor inputs. In addition, the HOBOMicroRX Water Level Station supports an easy-to-install water level sensor and integrated flow conversion for monitoring streams, lakes, wetlands, tidal areas, groundwater, and more. Logged data from the station is transferred at regular connection intervals to HOBOLink® web-based software where you can check the latest conditions, view graphs, configure sensors and alarms, set up a dashboard, download your data, or schedule data delivery via email or FTP. Inside its weatherproof enclosure, this compact station has a built-in LCD screen to check the current system configuration and status, start and stop logging, add and remove smart sensors, and connect to HOBOLink on demand. The station offers two primary power source options depending on your deployment needs: the RX2101 and RX2103 models include user-replaceable AA lithium batteries while the RX2102 and RX2104 models are designed with a built-in solar panel and rechargeable NiMH battery pack.

Specifications

Station

Operating Range	RX2101 and RX2103: -40° to 60°C (-40° to 140°F) RX2102 and RX2104: -20° to 60°C (-4° to 140°F)
Smart Sensor Connectors	5
Smart Sensor Network Cable Length	100 m (328 ft) maximum
Smart Sensor Data Channels	Maximum of 15 (some smart sensors use more than one data channel; see sensor manual for details)
Logging Rate	1 minute to 18 hours
Time Accuracy	±8 seconds per month in 0° to 40°C (32°F to 104°F) range; ±30 seconds per month in -40° to 60°C (-40° to 140°F) range
Battery Type/Power Source	RX2102 and RX2104: Integrated 1.7 watt solar panel and NiMH rechargeable battery pack; optional AC power adapter (P-AC-1) or external solar panel (SOLAR-xW) can be used in place of integrated solar panel RX2101 and RX2103: 6 AA 1.5 V lithium batteries or AC power adapter (P-AC-1)
Battery Life	<p>RX2102 and RX2104: Typical 3–5 years when operated in the temperature range -20° to 40°C (-4° to 104°F); operation outside this range will reduce the battery service life.</p> <p>Maximum connection rates with built-in solar panel, in full sun:</p> <ul style="list-style-type: none"> • 10 minute connections year round for latitudes less than ±40° • 10 minute connections through three seasons in other regions, reduced to 30 minute connections in winter <p>Maximum connection rates with external 5W or 15W solar panels:</p> <ul style="list-style-type: none"> • 10 minute connections year round, in full sun • Connection rate with external solar panels may be less if deployed in partial sun <p>Battery life without solar recharging, with hourly connections and 1 minute logging:</p> <ul style="list-style-type: none"> • RX2102: 3 months • RX2104: 2 months <p>RX2101 and RX2103: Battery life with daily connections:</p> <ul style="list-style-type: none"> • RX2101: 1 year with 1 minute logging • RX2103: 1 year with 2 minute logging <p>Battery life with hourly connections and 1 minute logging:</p> <ul style="list-style-type: none"> • RX2101: 3 months • RX2103: 2 months <p>Note: Deployments in areas with weak cellular strength could reduce battery life.</p>

Specifications (continued)

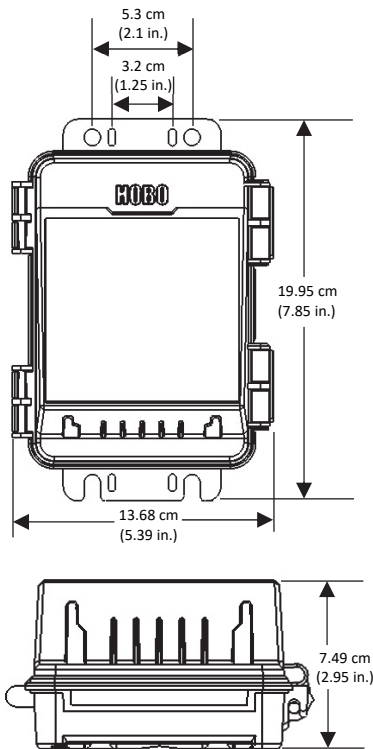

Dimensions



Water Level Sensor for RX2103 and RX2104 stations (MX2001-0x-S or MX2001-0x-Ti-S)

Memory	16 MB, 1 million measurements, continuous logging
Alarm Notification Latency	Logging interval plus 2–4 minutes, typical
Enclosure Access	Hinged door secured by two latches with eyelets for use with user-supplied padlocks
LCD	LCD is visible from 0° to 50°C (32° to 122°F); the LCD may react slowly or go blank in temperatures outside this range
Materials	Outer enclosure: Polycarbonate/PBT blend with brass inserts; Interior: Polycarbonate/PBT; Gasket: Silicone foam; Cable channel: Santoprene™ TPE; U-Bolts (not included): Steel with zinc dichromate finish
Dimensions	19.95 x 13.68 x 7.49 cm (7.85 x 5.39 x 2.95 in.); see diagrams at left
Weight	678 g (23.9 oz)
Mounting	Optional U-bolts are compatible with masts up to 4.14 cm (1.63 in.) mast diameter; can also be mounted with zip ties or mounted to a flat surface with screws
Environmental Rating	Weatherproof enclosure, NEMA 4X and IP66 (requires proper installation of cable channel system)
Wireless Radio	GSM/GPRS/EDGE: Quad band 850/900/1800/1900 MHz UMTS/HSPA+: Seven band 800/850/900/1800/1900/2100 MHz LTE: Twelve Band 700/800/850/900/1800/1900/2100/2600 MHz
Antenna	4G LTE
CE	The CE Marking identifies this product as complying with all relevant directives in the European Union (EU)
FCC	See last page, FCC ID QIPPLS62-W, IC ID:7830A-PLS62W

Water Level Sensor

Pressure (Absolute) and Water Level Measurements MX2001-01-S and MX2001-01-Ti-S

Operation Range	0 to 207 kPa (0 to 30 psia); approximately 0 to 9 m (0 to 30 ft) of water depth at sea level, or 0 to 12 m (0 to 40 ft) of water at 3,000 m (10,000 ft) of altitude
Factory Calibrated Range	69 to 207 kPa (10 to 30 psia), 0° to 40°C (32° to 104°F)
Burst Pressure	310 kPa (45 psia) or 18 m (60 ft) depth
Water Level Accuracy*	Typical error: ±0.05% FS, 0.5 cm (0.015 ft) water Maximum error: ±0.1% FS, 1.0 cm (0.03 ft) water
Raw Pressure Accuracy**	±0.3% FS, 0.62 kPa (0.09 psi) maximum error
Resolution	<0.02 kPa (0.003 psi), 0.21 cm (0.007 ft) water
Pressure Response Time (90%***)	<1 second at a stable temperature

Pressure (Absolute) and Water Level Measurements MX2001-02-S

Operation Range	0 to 400 kPa (0 to 58 psia); approximately 0 to 30.6 m (0 to 100 ft) of water depth at sea level, or 0 to 33.6 m (0 to 111 ft) of water at 3,000 m (10,000 ft) of altitude
Factory Calibrated Range	69 to 400 kPa (10 to 58 psia), 0° to 40°C (32° to 104°F)
Burst Pressure	500 kPa (72.5 psia) or 40.8 m (134 ft) depth
Water Level Accuracy*	Typical error: ±0.05% FS, 1.5 cm (0.05 ft) water Maximum error: ±0.1% FS, 3.0 cm (0.1 ft) water
Raw Pressure Accuracy**	±0.3% FS, 1.20 kPa (0.17 psi) maximum error
Resolution	<0.04 kPa (0.006 psi), 0.41 cm (0.013 ft) water
Pressure Response Time (90%***)	<1 second at a stable temperature

Specifications (continued)

Pressure (Absolute) and Water Level Measurements MX2001-03-S

Operation Range	0 to 850 kPa (0 to 123.3 psia); approximately 0 to 76.5 m (0 to 251 ft) of water depth at sea level, or 0 to 79.5 m (0 to 262 ft) of water at 3,000 m (10,000 ft) of altitude
Factory Calibrated Range	69 to 850 kPa (10 to 123.3 psia), 0° to 40°C (32° to 104°F)
Burst Pressure	1,200 kPa (174 psia) or 112 m (368 ft) depth
Water Level Accuracy*	Typical error: $\pm 0.05\%$ FS, 3.8 cm (0.125 ft) water Maximum error: $\pm 0.1\%$ FS, 7.6 cm (0.25 ft) water
Raw Pressure Accuracy**	$\pm 0.3\%$ FS, 2.55 kPa (0.37 psi) maximum error
Resolution	<0.085 kPa (0.012 psi), 0.87 cm (0.028 ft) water
Pressure Response Time (90%***)	<1 second at a stable temperature

Pressure (Absolute) and Water Level Measurements MX2001-04-S and MX2001-04-Ti-S

Operation Range	0 to 145 kPa (0 to 21 psia); approximately 0 to 4 m (0 to 13 ft) of water depth at sea level, or 0 to 7 m (0 to 23 ft) of water at 3,000 m (10,000 ft) of altitude
Factory Calibrated Range	69 to 145 kPa (10 to 21 psia), 0° to 40°C (32° to 104°F)
Burst Pressure	310 kPa (45 psia) or 18 m (60 ft) depth
Water Level Accuracy*	Typical error: $\pm 0.075\%$ FS, 0.3 cm (0.01 ft) water Maximum error: $\pm 0.15\%$ FS, 0.6 cm (0.02 ft) water
Raw Pressure Accuracy**	$\pm 0.3\%$ FS, 0.43 kPa (0.063 psi) maximum error
Resolution	<0.014 kPa (0.002 psi), 0.14 cm (0.005 ft) water
Pressure Response Time (90%***)	<1 second at a stable temperature

Water Level Sensor and Cable

Dimensions	Sensor (MX2001-0x-S and MX2001-0x-Ti-S): 2.54 cm (1.0 inches) diameter, 9.91 cm (3.9 inches) length Cable (CABLE-RWL-xxx): 0.47 cm ± 0.03 (0.185 inches ± 0.01) diameter, 0.2 to 400 m (0.65 to 1,312 ft) length Note: The length of the water level logger cable can vary -0% to +3% +10 cm (3.9 inches) from the length ordered.
Weight	Stainless sensor (MX2001-0x-S): Approximately 106 g (3.74 oz) in air; approximately 53.9 g (1.9 oz) in fresh water Titanium sensor (MX2001-0x-Ti-S): Approximately 80 g (2.83 oz) in air; approximately 37 g (1.3 oz) in fresh water Cable (CABLE-RWL-XXX): 39 g (1.38 oz) per 1 meter (3.28 ft)
Materials	Stainless sensor (MX2001-0x-S): Acetal housing, Viton and Buna-N O-rings, ceramic sensor in stainless steel end cap Titanium sensor (MX2001-0x-Ti-S): Acetal housing, Viton and Buna-N O-rings, ceramic sensor in Titanium end cap Cable (CABLE-RWL-XXX): Polycarbonate end cap, PVC end cap, polycarbonate collar nut, Viton O-rings, polyurethane jacket
Environmental Rating	IP68; cable is waterproof for continuous immersion up to 112 m (368 ft), refer to sensor model specifications for sensor depth rating

Barometric Pressure (RX2103 and RX2104 station)

Operation Range	66 to 107 kPa (9.57 to 15.52 psia)
Temperature Calibrated Range	-20 to 50°C (-4 to 122°C)
Accuracy	± 0.2 kPa (± 0.029 psi) over full temperature range at fixed pressure; maximum error $\pm 0.5\%$ FS
Water Level Accuracy*	Typical error: $\pm 0.075\%$ FS, 0.3 cm (0.01 ft) water Maximum error: $\pm 0.15\%$ FS, 0.6 cm (0.02 ft) water

Specifications (continued)

Resolution	<0.01 kPa (0.0015 psi)
Response Time	<1 second at stable temperature
Stability (Drift)	<0.01 kPa (0.0015 psi) per year

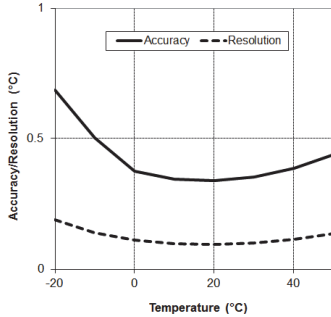

Plot A

Temperature (Water Level Sensors MX2001-0x-S and MX2001-0x-Ti-S)

Operation Range	-20° to 50°C (-4° to 122°F)
Accuracy	±0.44°C from 0° to 50°C (±0.79°F from 32° to 122°F), see Plot A
Resolution	0.1°C at 25°C (0.18°F at 77°F), see Plot A
Response Time (90%)	5 minutes in water (typical)
Stability (Drift)	0.1°C (0.18°F) per year

- * Water Level Accuracy: With accurate reference water level measurement, known water density, and a stable temperature environment. System Water Level Accuracy equals the sum of the Barometric Water Level Accuracy plus the selected sensor Water Level Accuracy.
- ** Raw Pressure Accuracy: Absolute pressure sensor accuracy includes all sensor drift, temperature, and hysteresis-induced errors.
- *** Changes in Temperature: Allow 20 minutes in water to achieve full temperature compensation of the pressure sensor. There can be up to 0.5% of additional error due to rapid temperature changes. Measurement accuracy also depends on temperature response time.

Table of Contents

Device Components and Operation	5	Setting up a Water Level Channel	15
LCD Operation	6	Setting up a Water Flow Channel for a V-Notch Weir	15
Setting up the Station	8	Setting up a Water Flow Channel for a Rectangular Weir	16
1. Log in to HOBOLink	8	Setting up a Water Flow Channel for a Trapezoidal Weir	17
2. Register the station	8	Setting up a Water Flow Channel for a General Flume	18
3. Mount the station	8	Setting up a Water Flow Channel for a Stage-Discharge	
4. Remove the cable channel. Make a note of how the		Table	18
cable channel is oriented when removing it.	8	Starting and Stopping Logging	19
5. Install the water level sensor if applicable (RX2103 and		Adding or Removing Smart Sensors	20
RX2104 models)	8	Adding or Removing a Water Level Sensor (RX2103 and	
6. Plug in smart sensors if applicable	9	RX2104 Models)	20
7. Grease and reinstall the cable channel.	9	Managing Connections to HOBOLink	20
8. Plug in the battery and wait for the station to connect		Deployment Guidelines	21
to HOBOLink.	10	Guidelines for All Models	21
9. Configure the station in HOBOLink	10	Guidelines for the RX2102 and RX2104 Models	21
10. Start logging	12	Guidelines for the RX2103 and RX2104 Models	21
11. Obtain a reference water level reading (RX2103 and		Installing the Grounding Wire	22
RX2104 models)	12	Care and Maintenance	22
12. Configure the water level and water flow channels in		Troubleshooting	23
HOBOLink (RX2103 and RX2104 models)	12	Battery Information for RX2101 and RX2103 Models	23
Viewing Data in HOBOLink	13	Battery Information for RX2102 and RX2104 Models	23
Setting System and Sensor Alarms	13		
System Alarms	13		
Sensor Alarms	14		
Setting up Water Level and Water Flow Channels in HOBOLink			
(RX2103 and RX2104 Models)	14		

Device Components and Operation

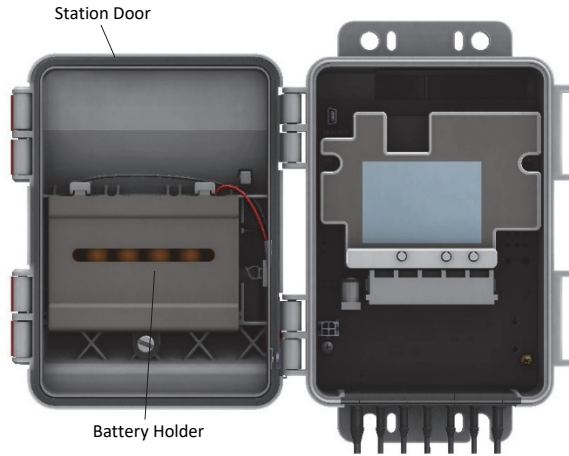

RX2101 model shown

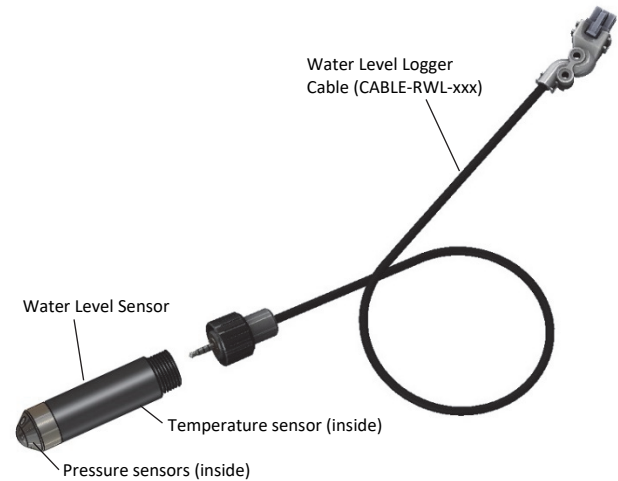

Station Door: This is the protective, hinged door covering the LCD and electronics. The station serial number and device key needed for HOBOLink registration are located on the inside of the door.

Battery Holder: The location where batteries are installed (AA 1.5 V lithium batteries in RX2101 and RX2103 models or a NiMH battery pack in RX2102 and RX2104 models (see both *Battery Information* sections).

Micro SIM Card: This enables cellular communications.

USB Port: Use this port to connect the station to the computer via USB cable as needed for HOBOWare® if you are installing your own micro SIM card or for data offload to CSV file.

LCD Screen: This shows details about system, module, and sensor operation (see *LCD Operation*).

Solar Panel Port: In RX2102 and RX2104 models, use this port to plug in the built-in solar panel or an external solar panel with a higher wattage (see *Setting up the Station*).

Battery Port: Use this port to plug in the internal battery cable (see *Setting up the Station* and both *Battery Information* sections).

AC Adapter Port: Use this port to plug in an AC adapter (see both *Battery Information* sections).

Cable Channel: Use this for routing sensor cables and other wires to create a weatherproof seal. Any open holes should be sealed with the integrated plugs (see *Setting up the Station* and *Deployment Guidelines*).

Smart Sensor Connectors: Use these input jacks to connect up to 5 smart sensors (see *Setting up the Station*). The station can support up to 15 smart sensor data channels; some smart sensors have more than one data channel.

Water Level Sensor Port: Use this port to connect a water level sensor in the RX2103 and RX2104 models (see *Setting up the Station*).

Connect/Search Button: Use this button to connect to HOBOLink or search for new smart sensors (see *LCD Operation*).

Start/Stop Button: Use this button to start and stop logging or clear a fault code (see *LCD Operation*).

Select Button: Use this button to cycle through information about the smart sensors and water level sensor module (see *LCD Operation*).

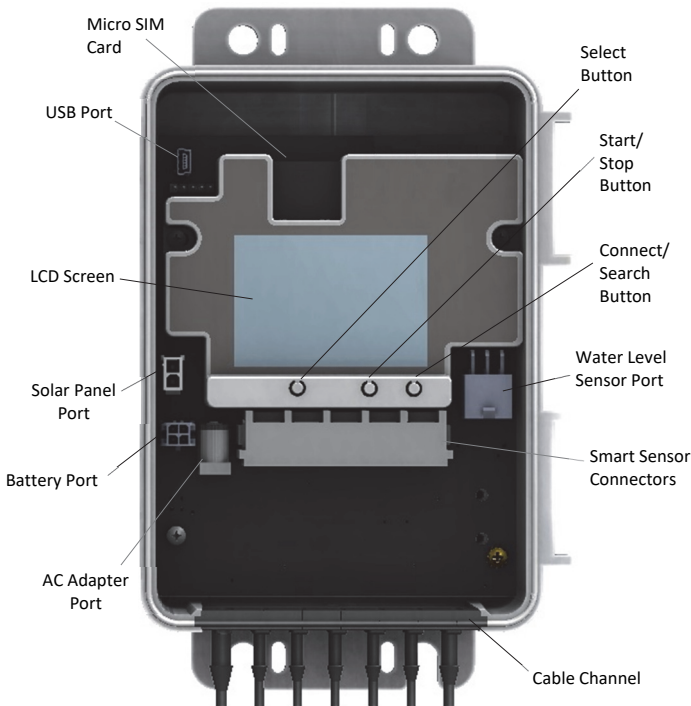

Internal RX2104 model shown

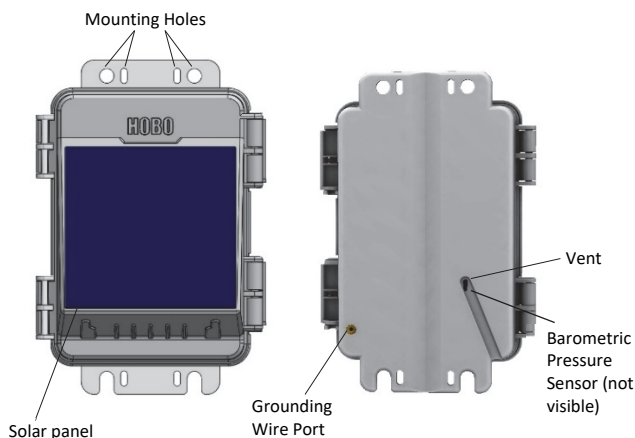

RX2104 model shown

Mounting Holes: Use the inner or outer holes at the top and bottom of the logger to mount it (see *Deployment Guidelines*).

Solar Panel: This is the 1.7 watt solar panel built into the front of the station door in RX2102 and RX2104 models.

Grounding Wire Port: Use this port on the back of the station to connect a grounding wire (CABLE-MICRO-G) (see *Installing the Grounding Wire*).

Vent: This vent allows pressure to equalize inside the station while keeping water out.

Barometric Pressure Sensor: This is the sensor located behind the vent in RX2103 and RX2104 models that logs barometric pressure for use with the water level sensor.

Water Level Sensor: This is the sensor for RX2103 and RX2104 models. The nose cone on the sensor houses the pressure sensors and the body of the sensor houses the temperature sensor.

Water Level Logger Cable: This is the cable that connects the sensor to the station via the water level sensor port (see *Setting up the Station*).

LCD Operation

This example shows all symbols illuminated on the LCD screen with an overview of what each section of the LCD represents. Refer to the table below for details about each section and associated symbols.

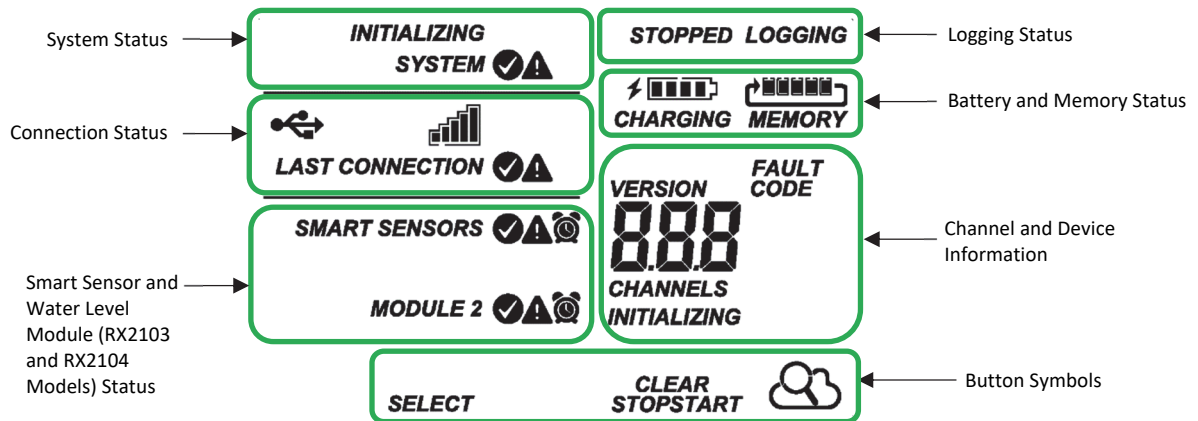

<p>System Status</p> <p>SYSTEM or INITIALIZING SYSTEM</p>	<p>This part of the LCD shows the overall system status.</p> <p>When the station is powered up, “Initializing System” flashes in the upper left part of the LCD. After initialization is complete, “System” remains illuminated and one of these symbols will appear:</p> <ul style="list-style-type: none"> ✔ indicates the system is ok. ⚠ indicates there is a problem with the system; check the Device Information panel on your station page in HOBOLink.
<p>Connection Status</p> <p>CONNECTION or LAST CONNECTION</p>	<p>This part of the LCD shows the status of the HOBOLink connection and other items.</p> <ul style="list-style-type: none"> 🔌 This indicates the station is connected to a USB cable. 📶 This shows the strength of the cellular signal; the more bars there are, the stronger the signal. This will blink while connecting to HOBOLink. <p>When the station is attempting to connect or is currently connected to HOBOLink, “Connection” flashes on the LCD. After the connection is complete, “Last Connection” remains illuminated and one of these symbols will appear:</p> <ul style="list-style-type: none"> ✔ indicates the last connection to HOBOLink was ok. ⚠ indicates there was a problem with the last connection; check the Connections log in HOBOLink.
<p>Smart Sensor and Module Status</p> <p>SMART SENSORS MODULE 2</p>	<p>This part of the LCD shows the status of the smart sensors and the water level sensor (RX2103 and RX2104 models). One of the following symbols will also appear next to smart sensors or module 2 (water level sensor) (if applicable):</p> <ul style="list-style-type: none"> ✔ indicates the smart sensor or water level sensor module is ok. ⚠ indicates there is a problem with the smart sensor or water level sensor module; check your device page in HOBOLink. 🔔 indicates a sensor alarm has tripped and will flash on the LCD until the alarm is cleared; check the Alarms log in HOBOLink.
<p>Logging Status</p> <p>STOPPED or LOGGING</p>	<p>This part of the LCD indicates whether the station is currently logging.</p> <p>“Stopped” indicates the station is not currently logging while “Logging” indicates it is currently logging. Press the Start/Stop button to start or stop logging as desired. Note that “Logging” will blink until the first data point is logged after the Start button is pressed. Pressing Start will also initiate a connection to HOBOLink. Pressing Stop will stop logging, but it will not initiate a connection to HOBOLink.</p>
<p>Battery and Memory Status</p>	<p>This part of the LCD shows the current battery level and memory.</p>



The battery indicator shows the approximate battery power remaining. In this example, the battery is fully charged. The lightning bolt will appear when an AC adapter or solar panel is plugged into the station. "Charging" will flash while the battery is being charged.

When the station is logging, it will record data indefinitely, with newest data overwriting the oldest data until the station is stopped. This continuous logging is represented by the arrow in this symbol. With normal communication, the memory used will be small, and this icon will show one bar. If the station is not able to connect to HOBOLink, this icon will show the amount of memory that is filled with data waiting to be read out at the next connection.

Channel and Device Information

This part of the LCD shows the number of channels and other information about each module. It also shows general device information. Press the Select button to scroll through the main screen, smart sensors screen, and module 2 (water level sensor, if applicable).

Main Screen

When viewing the main LCD screen, the total number of channels in use by the system is displayed. This is a combination of smart sensor channels and four channels for the water level sensor (if installed). In this example, 9 channels are shown on the main screen, which is a total of 5 smart sensor channels plus 4 channels for the water level sensor parameters.

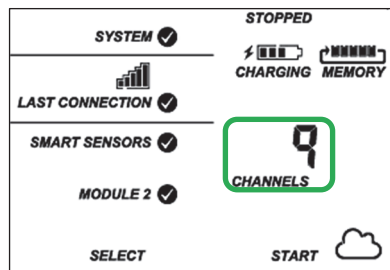

Smart Sensors Screen

When viewing the smart sensors screen, the number of smart sensor channels is displayed. Note that some smart sensors have more than one channel associated with them so the number of channels may not match the number of physical smart sensors. In this example, there are 5 smart sensor channels.

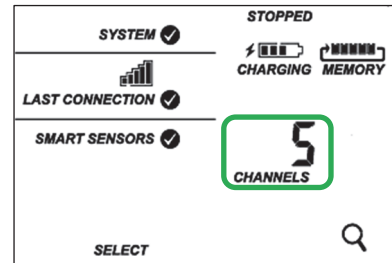

Module 2

The module 2 screen will only display if a water level sensor is installed (RX2103 and RX2104 models). The channel count is listed as 4 representing barometric pressure, water pressure, differential pressure, and water temperature. Note that water level and water flow channels are derived in HOBOLink and not included in the channel count shown on the station LCD.

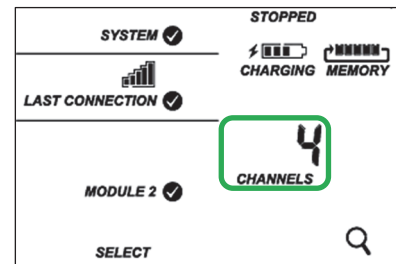

INITIALIZING

This will blink in the lower right part of the LCD when a firmware update is underway. It will display which module or element is being updated.



This is a numerical code that appears when a system fault has occurred. You may need to provide this code to Onset Technical Support. See *Troubleshooting* for details.

This is the version number of the station firmware. It only appears when powering up the device.

Button Symbols

Use the three buttons below the following symbols to operate the station. Press any of the three buttons to turn on the LCD.

SELECT

Press this button to cycle through status information about the smart sensors and the water level sensor module (if applicable).

START

Press this button to start logging. This option is not available while the station is actively connected to HOBOLink.

STOP

Press this button to stop logging. This option is not available while the station is actively connected to HOBOLink.



Press this button to connect to HOBOLink. This option is only available on the main LCD screen. It is not available when scrolling through smart sensor and module information with the Select button. In addition, this option is not available while a connection is underway or active.



Press this Search button for the station to detect all currently installed smart sensors. As you add or remove smart sensors while the station is stopped, press the Select button and then the Search button for the system to recognize your changes. This option is not available for smart sensors while the station is logging.

CLEAR

Use this button to clear a fault code.

Notes on LCD Operation:

- The LCD will turn off after 5 minutes of inactivity. Press any button to turn the LCD back on.
- There can be a delay before the LCD updates. For example, if you plug in an AC adapter, it may take a few seconds before the lightning bolt icon appears on the LCD. This delay is by design to preserve battery life.

Setting up the Station

Follow these steps to set up the station.

Tools required:

- A Phillips-head screwdriver for installing the water level sensor (RX2103 and RX2104 models) or mounting the station to a flat surface with screws.
- A ½ inch box wrench if using U-bolts to mount the station to a tripod or mast.
- Other tools may be required depending on the accessories you are using for your station deployment.

1. Log in to HOBOLink.

Go to www.hobolink.com and log in to an existing account or create a new one. You'll receive an email to activate the new account.

2. Register the station.

In HOBOLink, click Devices, then RX Devices, and click the Register a Device link. Give the station a name and enter the serial number and device key from the label inside the station door.

Note: If you are using your own micro SIM card, follow the instructions at <https://www.onsetcomp.com/support/manuals/23845-installing-micro-sim-rx2100-station-before-continuing>.

3. Mount the station.

There are three ways to mount the station using the built-in mounting tabs. **Note:** You can also defer mounting until the end of the process if you want to perform initial testing.

- Use the two sets of outer holes and 1-5/8 inch saddle-clamp U-bolts to attach the logger to a tripod or mast (this is the recommended method for mounting on a mast). Do not use U-bolts without the saddle clamps as that could bend the mounting tabs and damage the housing or compromise the weatherproof seal. The flat portion of the saddle clamps should be against the mounting tabs.

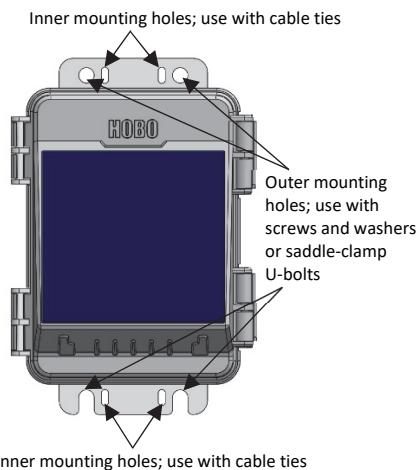

- Use the included cable ties with the two sets of inner holes to affix the logger to a PVC pipe or mast.

- Use the included screws and washers with the two sets of outer holes to adhere the logger to a wall or flat surface.

Important: See *Deployment Guidelines* and *Installing the Grounding Wire* for installation steps and other deployment guidelines.

4. **Remove the cable channel.** Make a note of how the cable channel is oriented when removing it.

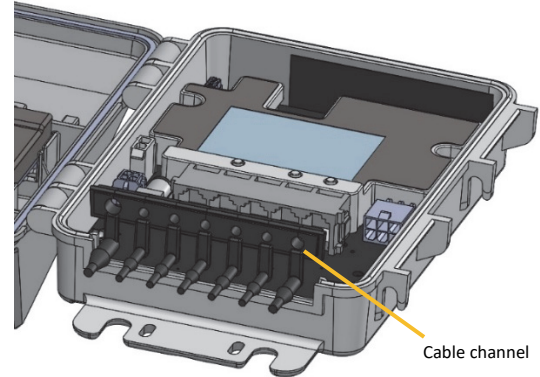

5. **Install the water level sensor if applicable (RX2103 and RX2104 models).**

- a. Insert the water level sensor cable jack into the water level sensor. Screw on locking nut (hand tight).

Important: Make sure the O-rings on the cable jack end and the cable and sensor mating housing surfaces are clear of any debris. Any contamination of these surfaces can cause leaks that may lead to sensor failure.

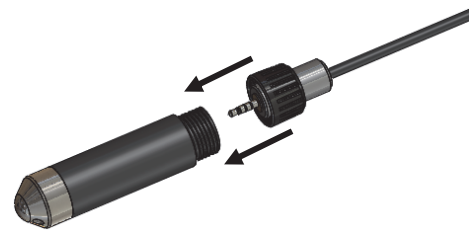

- b. Plug the other end of the water level sensor cable into the port on the right side of the board.

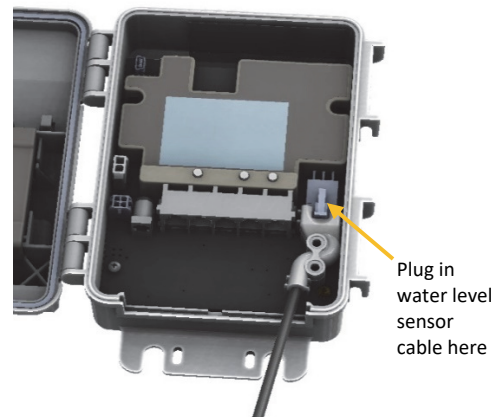

- c. Use a Phillips head screwdriver to secure the water level sensor cable in place with the two screws provided.

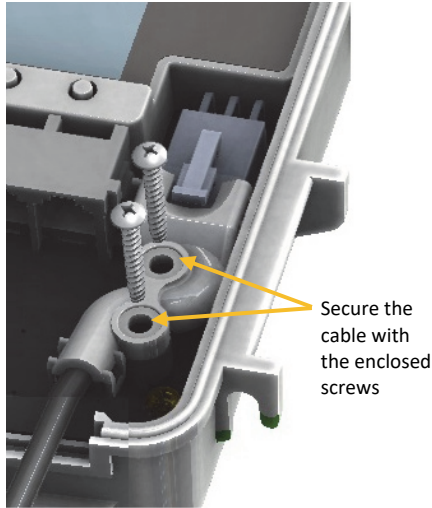

- d. Route the cable through the far-right hole in the cable channel.

6. Plug in smart sensors if applicable.

- a. Plug the smart sensors into the ports below the LCD
When using multiple smart sensors, it is easiest to start by plugging one into the leftmost or rightmost connector and then working your way across the connectors in order.

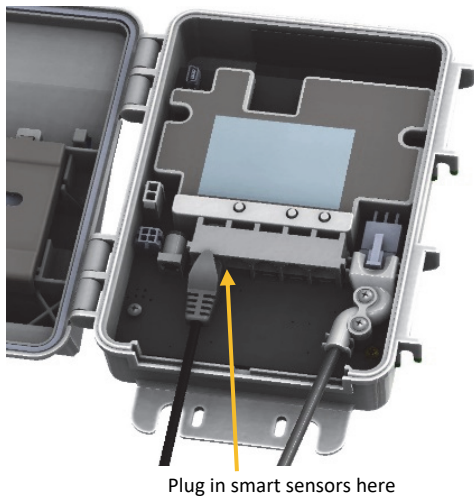

- b. Route the cables through the holes in the cable channel. There are slits in the cable channel above each hole to guide the cable into the hole. You may need to slightly bend the ends of the channel to reveal the slits and push each cable into the hole that lines up with the corresponding sensor connector.

7. Grease and reinstall the cable channel.

- a. Use the integrated plugs to fill any unused holes. Bend the plugs up so that you can push them into the holes. Once a plug is partially pushed through, you can pull on the part of the plug that is inside the case. You may need to bend the ends of the channel slightly to widen the holes for installing the plugs.

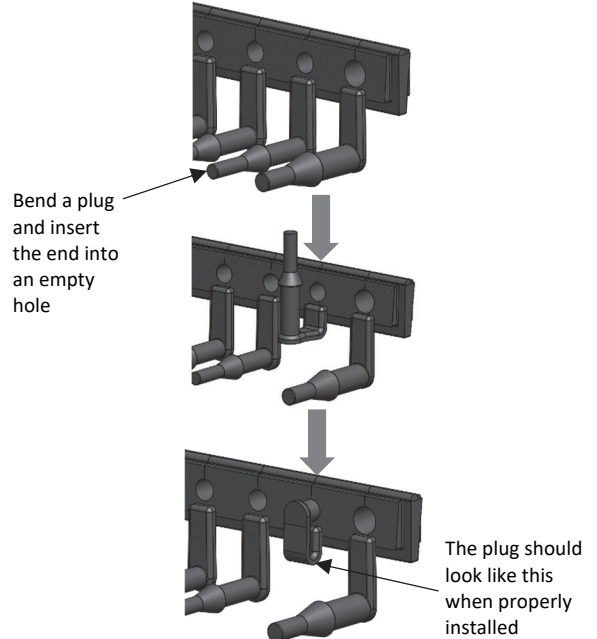

- b. Lightly coat the portion of the sensor cables that will be in the cable channel with a small amount of silicone grease (about the size of a pea).
- c. Lightly coat the bottom and two sides of the cable channel with silicone grease.
- d. Reinstall the cable channel in the station making sure the key on the bottom is inserted in the notch in the station enclosure.

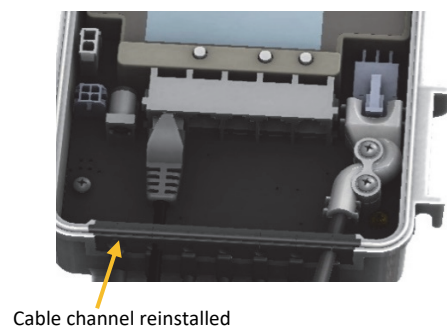
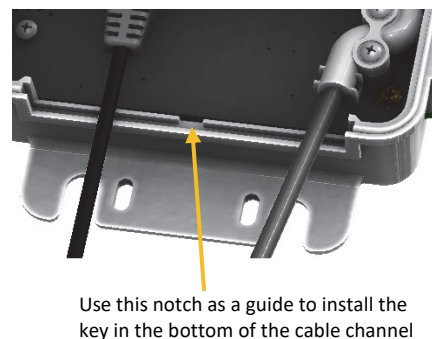

8. Plug in the battery and wait for the station to connect to HOBOLink.

Note for RX2103 and RX2104 models: If you are using the water level sensor, make sure it is plugged in before powering up the station in this step. Otherwise, only barometric pressure will be logged.

- a. Plug in the battery cable. For RX2102 and RX2104 models, plug in the solar panel cable for the built-in solar panel. If you are using an external solar panel, tuck the built-in solar panel cable inside the station door. Plug in the external solar panel cable. Lightly coat the portion of the cable that will be placed in the rubber cable channel with a small amount of silicone grease. Route the cable through the far-left hole in the cable channel.)

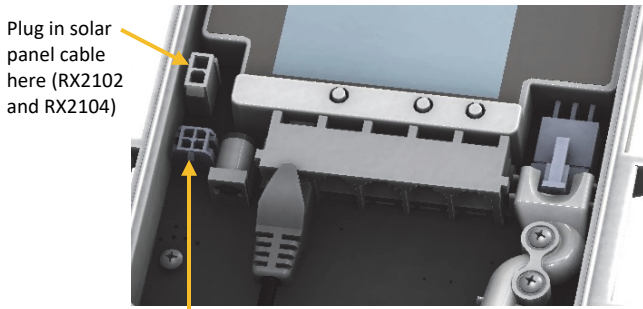

Connect the battery cable here

- b. Once the battery cable is plugged in, "Initializing System" will flash on the LCD. A checkmark appears next to "System" after the station initialization is complete.

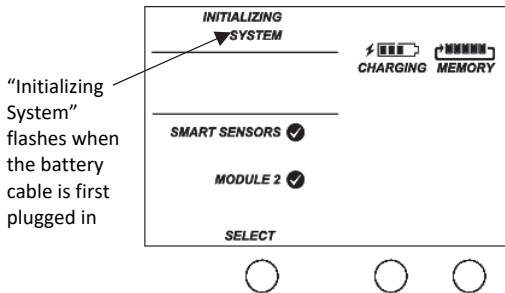

- c. After the station powers up, it will connect to HOBOLink automatically within two minutes. The cellular icon and "Connection" will flash while the connection is underway. Once the connection is complete, a checkmark appears next to Last Connection. Note that the entire initialization process may take several minutes; wait until Last Connection and the checkmark appears before continuing to step 9.

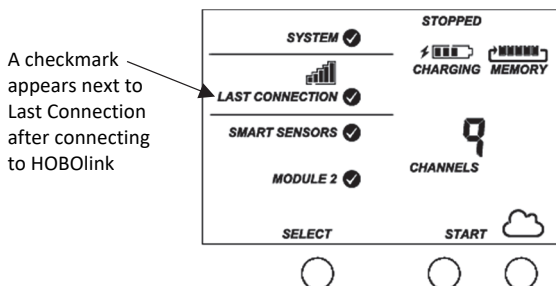

9. Configure the station in HOBOLink.

In HOBOLink, click Devices, then RX Devices and click the icon next to your station. Use the configuration screens in HOBOLink to finish setting up the station, starting with General Configuration (the nickname, time zone, and image for the station). Use the Next button to move from one configuration screen to the next or use the left menu to select a specific item to configure. Follow the steps in the next subsections to configure the readout settings, smart sensors (if applicable), and water level sensor (if applicable). **Note:** Click Save or Next in any screen to save your changes. You will lose any changes made if you click Back without clicking Next or Save first.

Important: Do not configure the water level and water flow channels yet. Set the logging and sampling interval for the water level sensors module and optionally add labels, scaling, or enable graphing. Continue to step 10 to start logging and then obtain a water reference level reading in step 11 before configuring water level and water flow.

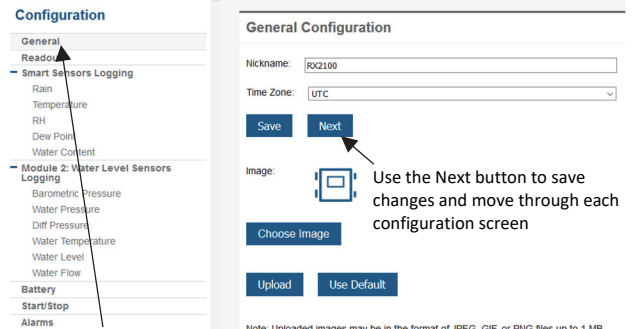

Or, you can choose a specific item to configure from this menu

Readout Configuration

- a. Click Readout from the Configuration menu.
- b. Set the connection interval, which is how often the station will connect to HOBOLink. The minimum connection interval depends on your communication plan.
- c. If you wish to set up a second connection interval, select the "Night mode" checkbox. Select when night mode should begin and end and then enter the connection interval you want to use during that part of the day. (The night mode schedule can take effect any time during the day; it does not have to be at night.) Use this option to save data in your communications plan (if applicable) or to conserve battery power at night when solar charging is unavailable. You can view current plan usage in the Device Information section on your station's page in HOBOLink.
- d. Click Save or click Next.

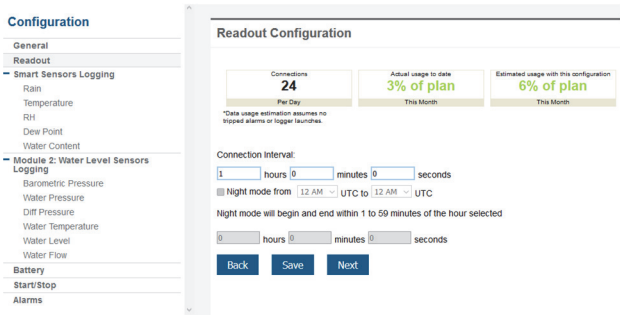

Smart Sensors Logging and Configuration

You can configure both the global settings that affect all smart sensors (logging interval and sampling interval) and the settings for each smart sensor (labels, graphs, and scaling).

- Click Smart Sensors Logging from the Configuration menu.
- Select the logging interval. This will be used by all configured smart sensors.
- Enable the sampling interval and enter the rate to use in minutes and seconds.

Tip: When a sampling interval is configured, the station will take multiple measurements within a given logging interval and then average them together to create a single logged data point. This is only an option for the following smart sensors that support measurement averaging: temperature (S-TMB-M0xx), PAR (S-LIA-M003), solar radiation (S-LIB-M003), barometric pressure (S-BPA-CM10 and S-BPB-CM50), 4-20mA input (S-CIA-CM14), 12-bit voltage input (S-VIA-CM14), and FlexSmart TRMS module (S-FS-TRMSA-D). Disable the sampling interval if none of your smart sensors support measurement averaging to avoid unnecessary drain on the battery power.

- Click Save or click Next.

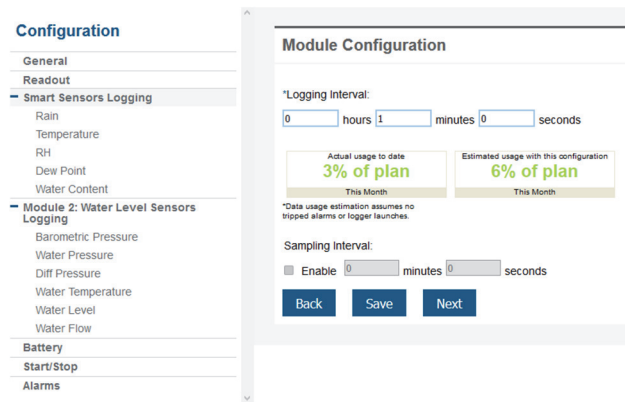

- Click a smart sensor from the Configuration menu.
- Type a label for the smart sensor (optional) and click to enable or disable the graph (enabled by default).
- To set up scaling for the smart sensor, click the Enable Scaling checkbox and fill in the Scaled Units, Multiplier, Offset, and Scaled Measurement Type fields.

- Click Save. You can also click Next to move from one smart sensor to the next and save the sensor configuration. Clicking Back does not save the configuration changes.

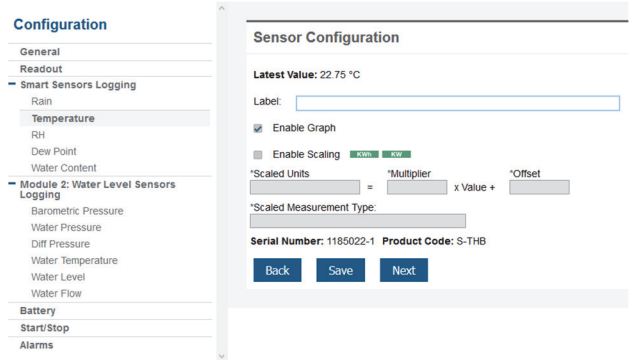

- Repeat steps e–h for any additional smart sensors you need to configure.

Water Level Sensor Module Configuration

You can configure both the global settings that affect all water level sensor channels (logging interval and sampling interval) and the settings for each individual channel. The water level sensor includes the following four channels that automatically record data at each logging interval: barometric pressure, water pressure, differential pressure, and water temperature. You can also configure water level and water flow channels that calculate data based on the logged data from the four sensor channels and the values you enter in HOBOLink.

- Click Water Level Sensors Logging from the Configuration menu.
- Select the logging interval. This will be used by all channels associated with this sensor.
- Enable the sampling interval (if desired) and enter the rate to use in minutes and seconds.
- Click Save or Next.

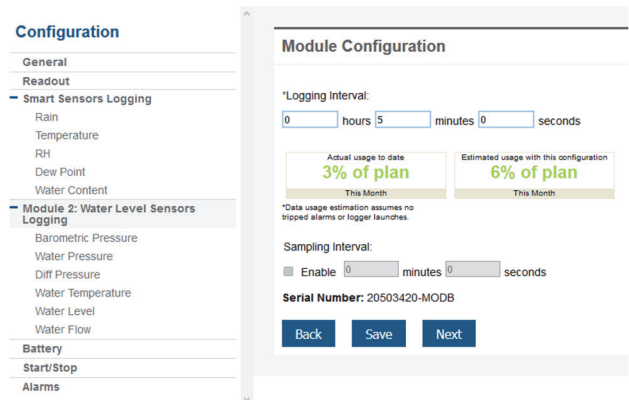

- Click Barometric Pressure from the Configuration menu.
- Type a label for the channel (optional) and click to enable or disable the graph (enabled by default).
- To set up scaling for the channel, click the Enable Scaling checkbox and fill in the Scaled Units, Multiplier, Offset, and Scaled Measurement Type fields.
- Click Save. Repeat steps e–h for Water Pressure, Diff Pressure, and Water Temperature.

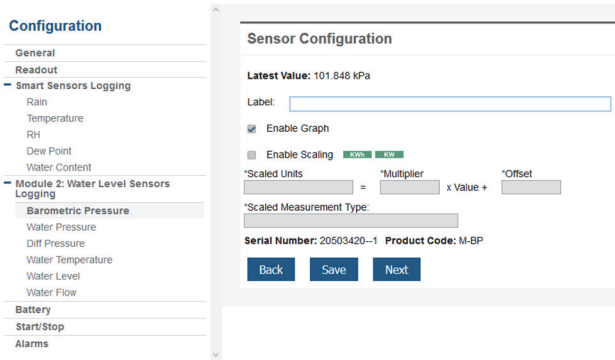

Important: Do not configure the water level and water flow channels yet. Continue to step 10 to start logging and then obtain a water reference level reading in step 11 first.

10. Start logging.

Press the Start button on the station to start logging. The station will connect to HOBOLink (“Connection” will blink on the LCD) and then logging will begin at the logging interval specified for smart sensors and the water level module (if applicable).

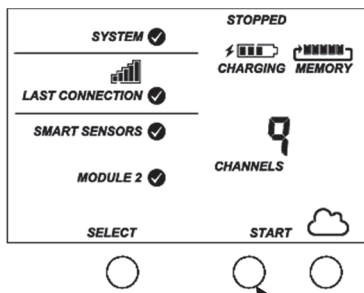

Press this button to start logging

Once logging begins, “Logging” appears in the upper right corner of the LCD as shown in the following example. “Logging” will blink until the first logging sample is recorded. At that point, it will stop blinking and remain illuminated until logging is stopped.

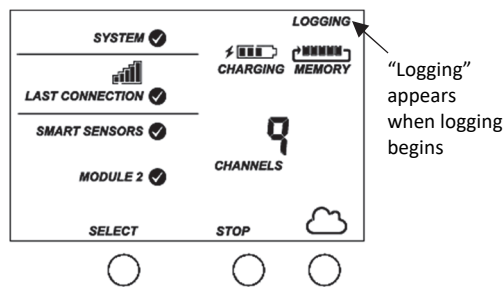

If you are not using a water level sensor, then the setup is complete. Measurements are uploaded to HOBOLink each time the station connects.

11. Obtain a reference water level reading (RX2103 and RX2104 models).

Make sure the water level sensor is deployed in its final location and the station is logging. Take a reference level reading, measuring the water level from your reference point.

Important: Note the reference level reading as well as the date and time it was taken.

12. Configure the water level and water flow channels in HOBOLink (RX2103 and RX2104 models).

Perform the following steps in the field in HOBOLink with a mobile device to verify that the system is logging the water level correctly while you are still at the station site.

Water Level Configuration

- In HOBOLink, select Devices and then RX Devices and click the icon next to your station.
- Under the water level sensors module in the Configuration menu, select Water Level.

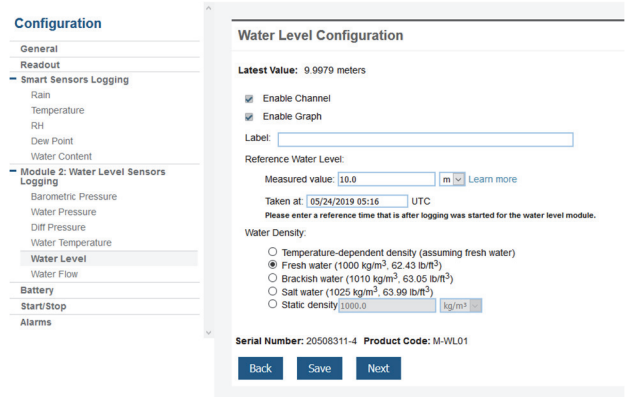

- Click the checkbox to Enable Channel.
- Click the checkbox to Enable Graph and type a label (optional).
- Enter the reference water level and date and time noted in step 11.
 - If the water level surface is **below** the reference point, enter the reference water level as a negative number.
 - If the water level surface is **above** the reference point, enter the reference water level as a positive number.
- See *Setting Up Water Level and Water Flow Channels in HOBOLink* for example diagrams showing reference points.
- Select the appropriate water density.
- Click Save.

Water Flow Configuration

- a. Select Water Flow from the Configuration menu.

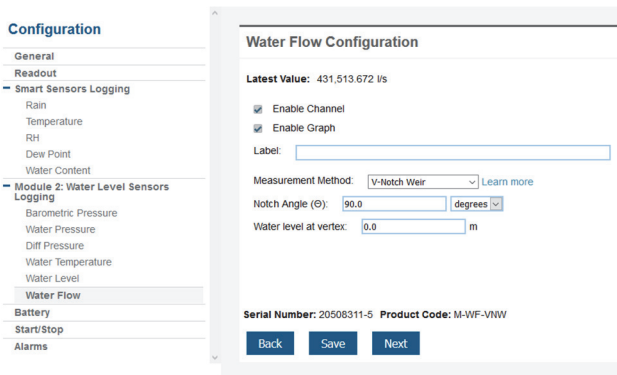

- b. Click the checkbox to Enable Channel.
- c. Click the checkbox to Enable Graph and type a label (optional).
- d. Choose the measurement method for water flow.
- e. Enter the appropriate information for the method selected. See *Setting Up Water Level and Water Flow Channels in HOBOLink* for more details on water flow measurement methods.
- f. Click Save.

Water level and flow data will be calculated starting with the next connection to HOBOLink. If you don't want to wait for the next scheduled connection, press the Cloud button on the station LCD to connect to HOBOLink immediately. Note that the reference water level information entered in this step will not affect data already stored in HOBOLink.

Viewing Data in HOBOLink

Data is uploaded to HOBOLink each time the device connects. For a snapshot of the latest conditions, click Devices, then RX Devices, and click the device name to view the readings from the last connection. You can also view any enabled graphs as shown in the following example.



Logged data is saved in a database. You can export this data on demand as needed or set up automatic exports that are delivered to email and/or FTP addresses on a schedule you specify.

To download and export data:

1. In HOBOLink, click Data and then Exports.
2. Click Create New Export.

3. Follow the instructions on the screen to select the name, format, time zone, and time frame, and then the devices and sensors to include in the export. Reorder the sensors as needed.
4. Click Save to keep these settings for future use or click Export Data to export immediately.

To set up a scheduled data delivery:

1. Click Data and then click Data Delivery.
2. Click Create New Delivery.
3. Under General Settings, type the name of the delivery schedule and the frequency of delivery. Enable the Active checkbox. Select other settings if desired.
4. Under Select Data to Export, choose the name of the custom data export you want to be delivered (or follow the previous set of steps to set up a new data export).
5. Under Data Destination, select FTP/SFTP or Email for the delivery method and fill in the appropriate fields.
6. Click Save. Data will then be delivered on the schedule you selected.

See the HOBOLink Help for more information on Data Delivery and other ways to monitor your station, such as using dashboards.

Setting System and Sensor Alarms

You can set up both system and sensor alarms in HOBOLink. System alarms can trip when there is a missed connection, the battery is low, or if there is a smart sensor failure. With a sensor alarm, you can configure an alarm to trip at one level and clear at another. In addition, if you are using a rain gauge with the RX2100 station, then you can set up an accumulated rain sensor alarm.

System Alarms

To add a system alarm:

1. In HOBOLink, click Devices and then RX Devices, and find the station you want to configure. Click the arrow next to  and select Alarm Configuration.
2. Click Edit System Alarms.
3. For Missed Connection alarms:
 - a. Under Communication, select the Missed Connection checkbox.
 - b. Set the length of time for HOBOLink to wait after the station has missed a connection before an alarm trips.
 - c. Select the action to be taken when this alarm trips: send an email or text. Enter the details and then select "Send on Clear Also" if you want an email or text when the alarm clears as well.

Important: Standard data fees and text messaging rates may apply when using text notifications. Onset does not charge a fee or guarantee delivery of text alerts, which is subject to your carrier's service and location. See the HOBOLink Help for additional details on alarm notifications.

- d. Click Add Action if you want multiple actions to be taken when the alarm trips (for example send an email and a text).

4. For Battery Low and Sensor Failure alarms:
 - a. Under Device, select the Battery Low and/or Sensor Failure checkboxes.
 - b. Select how you want to be notified when these alarms trip: by email or text. Enter the appropriate addresses and then select "Send on Clear Also" if you want an email or text when these alarms clear as well.
5. Click Add Action if you want multiple actions to be taken when the alarm trips (for example send an email and a text).
6. Click Save. Changes will take effect the next time the station connects to HOBOLink.

Red alarm symbols will appear in HOBOLink when these alarms trip (if enabled).

Sensor Alarms

To add a sensor alarm:

1. In HOBOLink, click Devices and then RX Devices, and find the station you want to configure. Click the arrow next to and select Alarm Configuration.
2. Click Add a Sensor Alarm.
3. Set up the Sensor Condition for the alarm.
 - a. Select the sensor.
 - b. **For rain gauge sensors:** This is based on accumulated rainfall in inches or mm (depending on the units set in HOBOLink) over a period of minutes or hours (up to 24). Enter the number of minutes or hours you want the rainfall to be accumulated over, and the amount of rain in inches or mm you want to trigger the alarm.
 - c. **For all other sensors and channels:** Select whether the alarm should trip above or below a value or outside a range. Enter the sensor reading(s) for the alarm threshold. Enter the number of logged data points you want the station to record before the alarm trips. **Note:** If you are setting up a sensor alarm for a water flow channel that is using a stage-discharge table, be sure the alarm limits are within the range of the stage-discharge values you are using.
 - d. If you selected the alarm to trip above or below a specific reading, then select when the alarm should clear: above or below the same value or a different value. Enter the value if necessary.
4. Select the action to be taken when the alarm trips: send an email or text. Enter the details and then select "Send on Clear Also" if you want an email or text when the alarm clears as well.

Important: Standard data fees and text messaging rates may apply when using text notifications. Onset does not charge a fee or guarantee delivery of text alerts, which is subject to your carrier's service and location. See the HOBOLink Help for additional details on alarm notifications.

5. Click Add Action if you want multiple actions to be taken when the alarm trips (for example, send an email and a text).
6. Add any optional notes for this alarm.

7. Click Save. Changes will take effect the next time the station connects to HOBOLink.
8. Repeat steps 2 through 7 for each additional sensor alarm you want to add. **Note:** There is a limit of eight alarms allowed for all water level sensor channels (this includes barometric pressure, water pressure, differential pressure, water temperature, water level, and water flow).

If an alarm trips on a smart sensor or water level sensor channel, the station will automatically connect to HOBOLink to report the tripped alarm. A red alarm symbol appears next to that sensor in HOBOLink when it trips. An alarm symbol will also appear on the LCD.

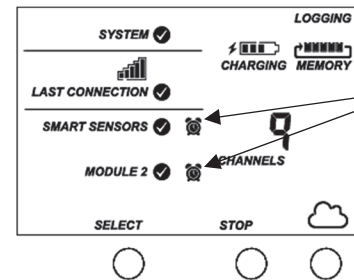

Note that for water level and flow alarms, HOBOLink calculates the corresponding differential pressure value so that this can trigger an alarm by the station the same as other sensors, and trigger an immediate connection if there is an alarm condition.

Alarms for HOBOLink calculated channels (such as dew point) are checked at the connection interval for the station. This is because calculated channels are generated from data uploaded at each connection interval.

Accumulated rain alarms are triggered by the station as soon as the alarm conditions are met. The alarm will remain tripped for one accumulation interval after the trip. For example, if you set the alarm to trip for 2 inches of rainfall accumulated in 4 hours, then it will be 4 hours before an alarm clear message is sent after the alarm is triggered--unless enough rain has continued to accumulate that causes the alarm to trip again.

Setting up Water Level and Water Flow Channels in HOBOLink (RX2103 and RX2104 Models)

RX2103 and RX2104 models support a water level sensor. When installed, the station will automatically log four measurement channels:

- Barometric pressure
- Water pressure
- Differential pressure
- Water temperature

In addition, you can set up two additional channels in HOBOLink:

- Water level
- Water flow

These derived channels are only available once enabled in HOBOLink. The data for these two channels are calculated at each logging interval based on the measurements from the pressure and temperature channels and the settings and values you enter in HOBOLink.

If a water level sensor is not physically connected to an RX2103 or RX2104 station, barometric pressure will be the only channel logged as that sensor is inside the station (aside from any measurements for installed smart sensors). You will not be able to set up water level and water flow unless you install the water level sensor as described in *Setting up the Station*. Similarly, if you unplug a water level sensor while a station is logging, only barometric pressure will be logged and the rest of the channels will report errors.

Setting up a Water Level Channel

Important: Make sure the station has started logging and you have taken a reference water level reading from the location where the sensor is deployed with the date and time of the reading before performing these steps.

To set up a water level channel:

1. In HOBOLink, select Devices and then RX Devices and click the  icon next to your station.
2. Under the water level module in the Configuration menu, select Water Level.
3. Click the checkbox to Enable Channel.
4. Click the checkbox to Enable Graph and type a label (optional).
5. Enter the reference water level and date and time the reading was taken.
 - If the water level surface is **below** the reference point as shown below, enter the reference water level as a negative number.

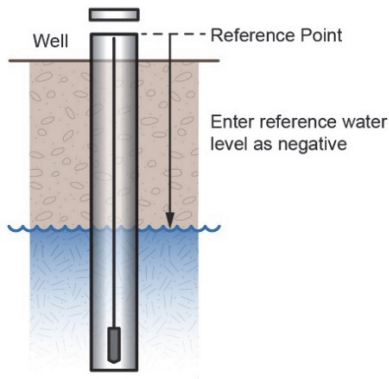

- If the water level surface is **above** the reference point as shown below, enter the reference water level as a positive number.

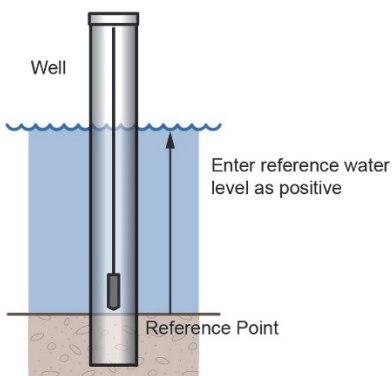

6. Select the appropriate water density for your deployment location.
7. Click Save.

Water level will be calculated starting with the next connection to HOBOLink. Note that the reference water level information entered in this step will not affect any previously logged data. It will only be used for data logged from the point of the next connection to HOBOLink forward. If this is the first time that water level has been configured for this station, then the data stored will go back to the date and time of the reference water level. If you make other updates to the reference water level, then the data will only be updated from the time of the next connection to HOBOLink.

Setting up a Water Flow Channel for a V-Notch Weir

If you are using a v-notch weir similar to the upper diagram below along with the water level sensor, then HOBOLink can calculate the flow rate for each water level reading using the following two values that you enter:

- The notch (vertex) angle in degrees or radians, which is represented as θ in the second diagram.
- The distance from the reference point to the v-notch vertex, which is represented as WL_v in the second diagram. This value must be entered in the same units as the reference water level you entered for the water level channel (meters or feet).

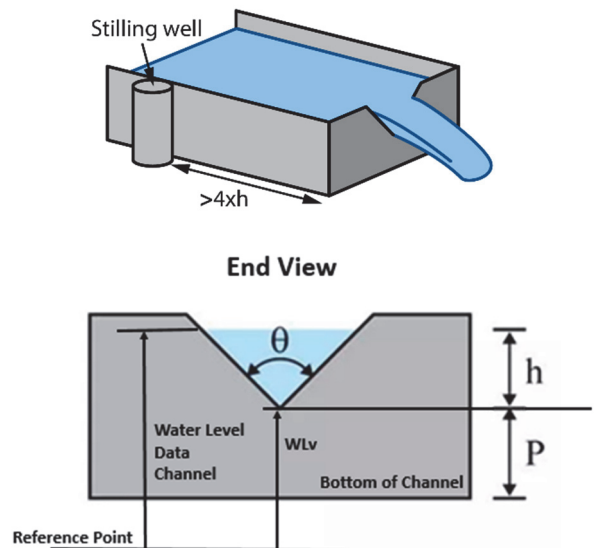

The HOBOLink water flow calculations for a v-notch weir assume the following:

- The stilling well with the water level sensor should be placed at a distance of at least $4 \times h_{max}$ upstream of the weir.
- In general, if the notch area is small relative to the area of the approach channel, the weir is “fully contracted” and these flow equations will work. More specifically, the ratio of the channel width to the v-notch width should be greater than 3, and the ratio of h_{max}/p should be less than 1. It may also work for weirs not meeting these guidelines if the approach channel is smooth, straight, and rectangular.

- The weir should be between 0.8 and 2 mm (0.03 and 0.08 inches) thick in the v-notch. If the bulk of the weir is thicker than 2 mm (0.08 inches), the downstream edge of the v-notch can be chamfered at an angle greater than 45° (60° is recommended) to achieve the desired thickness of the edges. Avoid water clinging to the downstream face of the weir.
- The head height (h) must be no more than 35% of the distance from the channel bottom to v-notch-vertex (P).
- The head height must be at least 6 cm (2.36 inches). When the head height is less than 6 cm (2.36 inches), the flow calculation will not be as accurate.
- The average width of the approach channel should be greater than 91 cm (3 ft).
- The bottom of the v-notch should be at least 45 cm (1.5 ft) above the bottom of the upstream channel.

Important: Make sure the station has started logging and you have configured the water level channel with a reference level reading before performing these steps.

To set up a water flow channel using a v-notch weir:

1. Click Devices and then RX Devices, and find the station you want to configure. Click the arrow next to the  icon and select Module/Sensor Configuration.
2. Under the water level module in the Configuration menu, select Water Flow.
3. Click the checkbox to Enable Channel.
4. Click the checkbox to Enable Graph and type a label (optional).
5. For the Measurement Method, select V-Notch Weir.
6. Enter the notch (vertex) angle of the weir in degrees or radians.
7. For the “Water level at vertex,” enter the distance from the reference point to the v-notch vertex in either meters or feet (using the same reference point and units you used for the reference water level in the water level channel).
 - If the vertex is the reference point, then enter 0.
 - If the reference point is the bottom of the channel, then the value is represented as P in the diagram earlier in this section.
 - If the reference point is above the water level (such as when using ground level as the reference point in a storm sewer), then enter a negative number.
 - If the reference point is below the water level, then enter a positive number.
8. Click Save.

Water flow will be calculated starting with the next connection to HOBOLink.

Tip: It is good practice to set an alarm for the water level just below the top of the v-notch so you know when the flow data is close to exceeding its valid range. See *Setting System and Sensor Alarms*.

Setting up a Water Flow Channel for a Rectangular Weir

If you are using a rectangular thin-plate weir similar to the diagram below on the left along with the water level sensor, then HOBOLink can calculate the flow rate for each water level reading using four values that you enter. Note that these values must be entered in the same units as the reference water level you entered for the water level channel (meters or feet). The values are:

- The notch width, which is represented as b in the second diagram.
- The channel width, which is represented as B in the second diagram.
- The notch height above the channel floor, which is represented as P in the second diagram.
- The distance from the water level reference point to the notch crest, which is represented as WLc in the second diagram.

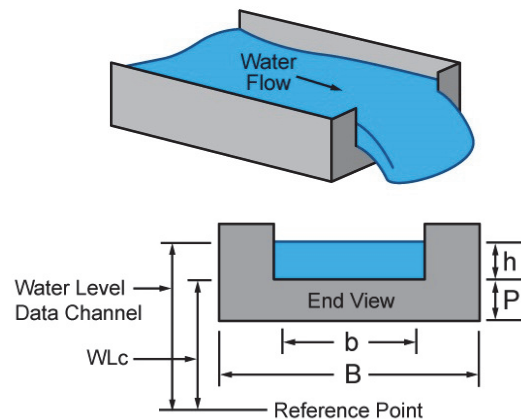

The HOBOLink water flow calculations for a rectangular weir assume the following:

- The range for the weir opening width is 0.15 to 6 m (0.5 to 20 ft).
- The notch height (P) must be at least 0.1 m (0.33 ft).
- Either $B = b$ (full-width weir) or $B - b$ must be at least 0.2 m (0.66 ft) (contracted weir).
- The weir should be between 1 to 2 mm (0.03 to 0.08 inches) thick in the opening. If the bulk of the weir is thicker than 2 mm (0.08 inches), the downstream edge of the opening can be chamfered at an angle greater than 45° (60° is recommended) to achieve the desired thickness of the edges, and avoid water clinging to the downstream face of the weir.
- The range for the head height (h) is 0.03 to 1.4 m (0.18 to 4.5 ft).
- The range for the flow rate is from 3.45 to 17,188 l/s (0.122 to 607 ft³/s).
- The value of h/p cannot be greater than 2.5.
- Water surface downstream of the weir should be at least 0.06 cm (2.36 inches) below the weir crest (i.e. below the bottom of the opening).

Important: Make sure the station has started logging and you have configured the water level channel with a reference level reading before performing these steps.

To set up a water flow channel using a rectangular weir:

1. Click Devices and then RX Devices, and find the station you want to configure. Click the arrow next to the  icon and select Module/Sensor Configuration.
2. Under Module 2: Water Level Sensors Logging on the left menu, select Water Flow.
3. Click the checkbox to Enable Channel.
4. Click the checkbox to Enable Graph and type a label (optional).
5. For the Measurement Method, select Rectangular Weir.
6. Enter the notch width in either meters or feet. **Note:** Use the same units for this and all rectangular weir values as you entered for the reference water level in the water level channel.
7. Enter the channel width in either meters or feet.
8. Enter the notch height above the channel floor in either meters or feet.
9. For the Distance from Water Level Ref Point to Notch, enter the distance from the reference point to the notch crest in either meters or feet.
 - If the notch crest is the reference point, then enter 0.
 - If the reference point is the bottom of the channel, then the value is represented as P in the diagram earlier in this section.
 - If the reference point is above the water level (such as when using ground level as the reference point in a storm sewer), then enter a negative number.
 - If the reference point is below the water level, then enter a positive number.
10. Click Save.

Water flow will be calculated starting with the next connection to HOBOLink.

Setting up a Water Flow Channel for a Trapezoidal Weir

If you are using a trapezoidal or Cipoletti thin-plate weir similar to the diagram below on the left along with the water level sensor, then HOBOLink can calculate the flow rate for each water level reading using two values that you enter. Note that these values must be entered in the same units as the reference water level you entered for the water level channel (meters or feet). The values are:

- The width at the base of the notch, which is represented as b in the second diagram.
- The distance from the water level reference point to the notch crest, which is represented as WLC in the second diagram.

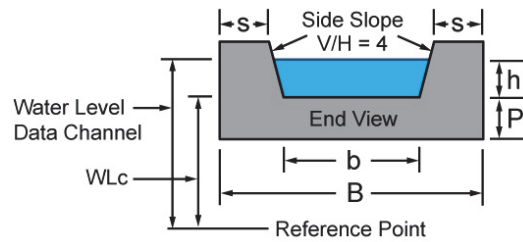
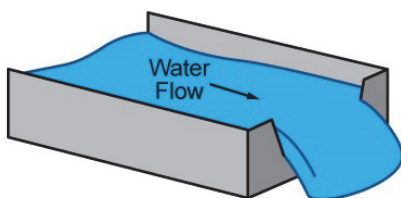

The HOBOLink water flow calculations for a trapezoidal weir assume the following:

- The slopes of the notch sides must be 4 (vertical change / horizontal change).
- Head height (h) should be measured at a distance of at least 4 x hmax upstream of the weir.
- The weir should be between 1 to 2 mm (0.04 to 0.08 inches) thick in the opening. If the bulk of the weir is thicker than 2 mm (0.08 inches), the downstream edge of the opening can be chamfered at an angle greater than 45° (60° is recommended) to achieve the desired thickness of the edges and avoid water clinging to the downstream face of the weir.
- Water surface downstream of the weir should be at least 0.06 m (0.2 ft) below the weir crest (i.e. below the bottom of the opening).
- The head height (h) must be at least 0.06 m (0.2 ft), but less than b/3.
- The crest height above the channel floor (P) is measured from the bottom of the upstream channel and should be greater than 2 x hmax.
- "S" is measured from the sides of the channel and should be greater than 2 x hmax.

Important: Make sure the station has started logging and you have configured the water level channel with a reference level reading before performing these steps.

To set up a water flow channel using a trapezoidal weir:

1. Click Devices and then RX Devices, and find the station you want to configure. Click the arrow next to the  icon and select Module/Sensor Configuration.
2. Under Module 2: Water Level Sensors Logging on the left menu, select Water Flow.
3. Click the checkbox to Enable Channel.
4. Click the checkbox to Enable Graph and type a label (optional).
5. For the Measurement Method, select Trapezoidal Weir.
6. Enter the notch width at the bottom in either meters or feet, using the same units as you entered for the reference water level in the water level channel.
7. For the Distance from Water Level Ref Point to Notch, enter the distance from the reference point to the notch crest in either meters or feet (using the same reference point and units you used for the reference water level).
 - If the notch crest is the reference point, then enter 0.

- If the reference point is the bottom of the channel, then the value is represented as P in the diagram earlier in this section.
- If the reference point is above the water level (such as when using ground level as the reference point in a storm sewer), then enter a negative number.
- If the reference point is below the water level, then enter a positive number.

8. Click Save.

Water flow will be calculated starting with the next connection to HOBOLink.

Setting up a Water Flow Channel for a General Flume

If you are using a flume along with the water level sensor, then HOBOLink can calculate the water flow using a general flow equation supported by a wide range of flumes that require only one water level measurement to calculate flow, including ramp, cutthroat, Parshall as well as broad-crested rectangular weirs. The equation that HOBOLink uses is: $Water\ Flow\ (Q) = C * (Water\ Level - Head\ Offset)^n$. Flumes that require two or three water level measurements to calculate flow are not supported.

For this equation to be accurate, there are constraints on the flow conditions and flume design, including:

- Minimum and maximum flow rates
- Minimum and maximum head levels
- Ratio of the width of the weir/flume to the head
- Ratio of the height of the weir/flume to the head
- Location in the flume or weir for measuring the head.

The constraints depend on the type and characteristics of the flume you are using, which can be obtained from the flume manufacturer.

Important: Make sure the station has started logging and you have configured the water level channel with a reference level reading before performing these steps.

To set up a water flow channel using a general flume:

1. Click Devices and then RX Devices, and find the station you want to configure. Click the arrow next to the  icon and select Module/Sensor Configuration.
2. Under the water level module in the Configuration menu, select Water Flow.
3. Click the checkbox to Enable Channel.
4. Click the checkbox to Enable Graph and type a label (optional).
5. For the Measurement Method, select General Flume.
6. For the Flume Coefficient, enter the C value listed in your flume's equation table, which can typically be found in the flume manufacturer's documentation. The Flume Coefficient may also be labeled K by some manufacturers so be sure to check how the coefficient is being used in their equation to make sure it is the right one to enter here.
7. For the Head Offset, enter the value in either meters or feet, using the same units as you entered the reference water level in the water level channel. An example of Head Offset is shown in the following diagram of a ramp flume.

- If you are using a ramp flume as shown in the diagram below and the top of the ramp is the reference point, then enter 0.
- If you are using a ramp flume and the bottom of the channel leading to the ramp (or crest) is the reference point, then enter the height of the ramp or crest for the Head Offset (represented as P in the diagram).

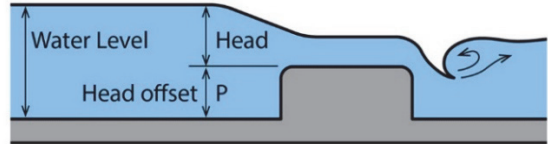

For other types of flumes, such as this example diagram where the water level (or H) is being measured from the bottom of the flume:

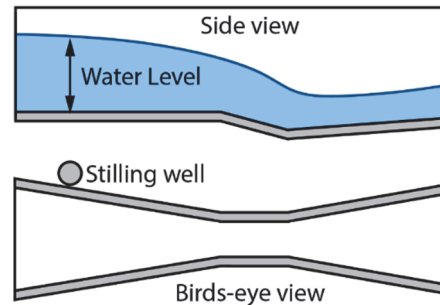

- If the bottom of the flume is the reference point for both the water level and head, then enter 0 for the head offset.
- If the reference point is above the water level (such as when using ground level as the reference point in a storm sewer), then enter a negative number.
- If the reference point is below the water level, then enter a positive number.

8. For the Head Exponent, enter the n value listed in your flume's equation table, which can typically be found in the flume manufacturer's documentation.

9. Click Save.

Water flow will be calculated starting with the next connection to HOBOLink.

Setting up a Water Flow Channel for a Stage-Discharge Table

You can set up a water flow channel that is calculated based on up to 20 stage-discharge points that you enter. Keep in mind that the units of the stage-discharge table for water flow are assumed to be the same as those entered for the reference water level. If the reference water level was entered in meters, then points in the table must be entered in meters and l/s (liters per second). If the reference water level was entered in feet, then points in the table must be entered in feet and cfs (cubic feet per second).

Before you begin setting up the channel, you will need to determine the values to enter into the stage-discharge table. HOBOLink does not derive a stage-discharge curve. Use another method to determine the stage-discharge curve for your site and then enter points from that curve into the HOBOLink stage-discharge table. HOBOLink linearly interpolates between the points that you enter. You can estimate and enter intermediate

points as needed to match your stage-discharge curve as best as possible. HOBOLink does not extrapolate beyond the lowest and highest stage values that you enter so make sure to enter values that span the full range of potential stage levels for your site, including flood conditions. Any measured water levels that are outside of the range you enter will be shown as sensor errors (-888.88) for the water flow channel.

Follow these guidelines for getting a stage-discharge rating curve for your site:

- If you are working with a USGS gaging site, you can use the USGS WaterWatch Customized Rating Curve Builder to get the rating curve for that site at <https://waterwatch.usgs.gov/?id=mkrc>.
- If there is not an existing stage-discharge rating curve for your site, then you will need to build one. This requires measuring stage and discharge at multiple stage levels over time and then creating a stage-discharge curve. A good reference on measuring stage and discharge is at https://www.usgs.gov/special-topic/water-science-school/science/how-streamflow-measured?qt-science_center_objects=0#qt-science_center_objects. More detailed information can also be found at <https://pubs.usgs.gov/tm/tm3-a8/pdf/tm3-a8.pdf>.

Once you have enough stage and discharge measurements for your site, you can use those measurements to create the stage-discharge curve for the site. There are two common ways to do this:

- Use a commercially available rating curve software tool, such as AQUARIUS or DataWise.
- Create your own stage-discharge curve fit for your stage-discharge measurements with a spreadsheet, such as Excel, or with a statistical program, such as R. The most common equation used for stage-discharge curves is Manning’s Equation.
 - Once you have selected the type of equation to use, try different coefficients in the equation to determine which ones provide the best fit for your stage-discharge measurements.
 - Use the selected equation to determine a set of values to enter in the HOBOLink stage-discharge table. If there are any levels at which there is a significant change in the stream profile, you will need to account for those as well. For example, when a stream overflows its banks, the stage-discharge relationship will change dramatically. The curve fit equation will no longer be valid so you will need a different curve-fit equation for stage levels in this range.

Important: Make sure the station has started logging and you have configured the water level channel with a reference level reading before performing these steps.

To set up a water flow channel using a stage discharge table:

1. Click Devices and then RX Devices, and find the station you want to configure. Click the arrow next to the  icon and select Module/Sensor Configuration.
2. Under the water level module in the Configuration menu, select Water Flow.
3. Click the checkbox to Enable Channel.

4. Click the checkbox to Enable Graph and type a label (optional).
5. For the Measurement Method, select Stage Discharge Table.
6. Enter each pair of stage-discharge points. Click Add A Row to add up to 20 pairs of points.
 - If you entered the reference water level in meters when setting up the water level channel, then the points in the table must be entered in meters and l/s.
 - If you entered the reference water level in feet when setting up the water level channel, then the points in the table must be entered in feet and cfs.
7. Click Save (or click Next to move to the next configuration page).

Water flow will be calculated starting with the next connection to HOBOLink.

Starting and Stopping Logging

You can start and stop logging with the Start/Stop button on the station or from HOBOLink.

To start and stop logging with the station:

1. When the station is stopped, press the Start button to start logging. The device will connect to HOBOLink (“Connection” will blink on the LCD) and then logging will begin at the logging interval specified for smart sensors and water level sensor (if applicable).

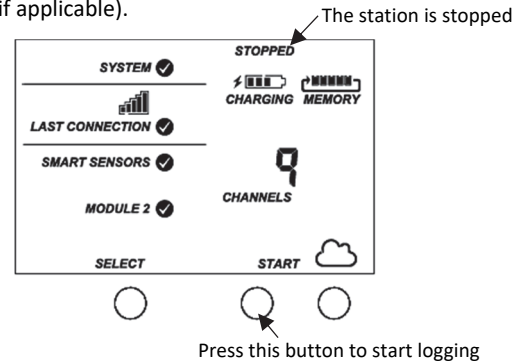

2. To stop logging, press the Stop button. Logging stops immediately. Note that the station does not immediately connect when the station is stopped, but it will continue to connect to HOBOLink at the connection interval set in HOBOLink even if it is not logging.

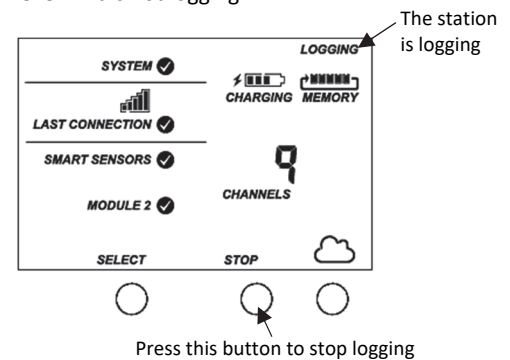

To start and stop the station from HOBOLink:

1. Click Devices and then RX Devices, and find the station you want to start or stop. Click the arrow next to  and select Start/Stop.

- Click Start or Stop. The station will start or stop logging the next time it connects to HOBOLink.

Adding or Removing Smart Sensors

To add or remove smart sensors from the station:

- If the station is currently logging, press the Stop button to stop it.
- Press the Connect button and wait for the station to connect to HOBOLink so that all the latest data is offloaded before changing smart sensors.
- Unplug any smart sensors you wish to remove. Plug in any new smart sensors. Lightly coat the portion of the cable(s) that will be placed in the cable channel with a small amount of silicone grease. Push each new sensor cable into the hole that lines up with the corresponding sensor connector. Use the integrated plugs in the cable channel to fill any empty holes.
- Press the Select button to view the smart sensors on the LCD screen.

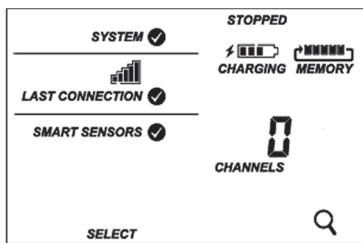

Press the Select button to view the smart sensor screen

Press the Search button for the station to find all connected smart sensors

- Press the Search button for the station to detect all the smart sensors currently connected (the magnifying glass icon should be visible as in the previous example).
- Press the Start button to begin logging again. The station will automatically connect to HOBOLink.
- Make sure the cable channel is securely in place and close the station door.
- Make any configuration changes in HOBOLink as desired, such as adding sensor labels or scaling (see *Setting up the Station*).

Note that any existing alarms associated with removed sensors will still be listed in HOBOLink. See the HOBOLink Help for details on deleting alarms.

Adding or Removing a Water Level Sensor (RX2103 and RX2104 Models)

To add or remove a water level sensor from the station:

- If the station is currently logging, press the Stop button to stop it.
- Press the Connect button and wait for the station to connect to HOBOLink so that all the latest data is offloaded before adding or removing the water level sensor.
- Power down the station by disconnecting the battery cable.

- If you are removing a water level sensor, unscrew the two screws and unplug the sensor cable from the water level sensor port.
- If you are adding a water level sensor, plug the sensor cable into the water level sensor port and secure the cable in place with two screws. Be sure the other end of the cable is plugged into the water level sensor. (See *Setting up the Station* for more details.)
- Route the cable through the far-right hole in the cable channel.
- Reconnect the battery cable.
- After the station powers up, the channel count on the LCD should be updated. If you removed the sensor, the total channel count will decrease by three. If you added the sensor, the channel count will increase by three. (Barometric pressure is always included in the channel count whether the sensor is plugged in or not.)

If you added a water level sensor, be sure to obtain a reference water level reading and configure the water level and water flow channels as described in *Setting up the Station* and *Setting up Water Level and Water Flow Channels in HOBOLink*.

Managing Connections to HOBOLink

The station will connect to HOBOLink on the connection interval you selected in Readout Configuration.

To change the connection schedule:

- Click Devices and then RX Devices, and find the station you want to configure. Click the arrow next to  on the Devices page and select Readout Configuration.
- Set the connection interval. The minimum connection interval depends on your communication plan.
- If you wish to set up a second connection interval, select the "Night Mode" checkbox. Select when night mode should begin and end and then enter the connection interval you want to use during that part of the day.
- Click Save. The changes to the connection interval will take place the next time the station connects to HOBOLink.

You can also connect to HOBOLink from the station at any time, regardless of the connection schedule. Press the Connect button on the station to connect to HOBOLink. Unless the station is running on a night mode connection interval, the normal connection schedule will then restart after the connection is complete. For example, a station is configured to connect hourly and the last connection on its regular schedule occurred at 10:05. If you use the Connect button on the station to connect to HOBOLink at 10:15, the next connection will then be about 11:15 based on the one-hour connection interval. Similarly, if a station misses a connection, the connection schedule will shift depending on the time of the next successful connection. While the station is using a second, night mode schedule, all connections will follow that schedule only; any extra connections while the station is in night mode will not cause a shift in the connection schedule.

Also note that the station will connect to HOBOLink when the device is powered up and when you press the Start button.

Note: All connections to HOBOLink count toward your communications plan. If the station is nearing its limit for monthly cell use, minimize unscheduled connections. This

includes any connections for alarms or changes you make to the connection schedule. You can also increase the connection interval to reduce the number of connections to HOBOLink per day. Go to the Device Information section on your station page in HOBOLink to check the status of the monthly communications plan usage for the station.

Deployment Guidelines

Follow the guidelines and steps in this section for deploying and mounting the station.

Guidelines for All Models

- Check the signal strength on the LCD in the location you wish to deploy the station to make sure it will be able to reliably connect to HOBOLink. The station may have difficulty connecting if there is only one bar illuminated in the signal strength icon on the LCD. (The signal strength shown on the LCD is from the last connection.)
- The station must be mounted at least one foot from all sensors to avoid interference from the built-in radio module and antenna with the measurements made by the sensors.
- Make sure the station remains in a vertical position once it is placed in its deployment location to prevent pooling of water on the cable entries. In addition, if it is mounted horizontally, the battery could be damaged over time in RX2102 and RX2104 models as it is charged and the antenna in all models will not have optimal range.
- If possible, avoid sites immediately adjacent to radio/television/microwave towers and equipment. In rare situations, strong electromagnetic interference may result in sensor network errors.
- If you are using a wind speed/direction sensor or if the station will be installed on a roof or in a location with exposure to lightning, use a grounding wire (CABLE-MICRO-G). A grounding wire may also reduce potential sensor errors that can result from installing near other radio or electrical equipment or antennas. See *Installing the Grounding Wire*. Also, ground the tripod or mast using appropriate grounding, such as the Grounding Kit (M-GKA).
- Take note of the mounting considerations in the sensor manuals at www.onsetcomp.com/support/manuals for additional guidelines for the sensors you are using.
- Make sure all cables and wires are fastened securely and routed through the cable channel. Any empty holes in the cable channels need to be filled with the integrated plugs to ensure the station is weatherproof (see the diagrams in *Setting up the Station* for how to insert the plugs).
- When using the AC adapter (P-AC-1) with the cable channel installed, route the AC adapter cable through the far-left hole in the cable channel. Tuck the cable into the left side of the hole and use the integrated cable channel plug in the same hole (see the diagrams in *Setting up the Station* for how to insert the plug). The far-left hole is slightly bigger than the other holes in the cable channel and can accommodate both the AC adapter cable and the integrated plug at the same time.

- Do not store excess sensor cable wire coiled inside the station case or within one foot outside the case.
- Protect cables and wires with conduit. Exposed cables can be chewed by rodents.
- Make sure the total cable length for all installed smart sensors does not exceed 100 m (328 ft).
- Consider using a padlock to restrict access to the station. With the station door closed, hook a padlock through one of the latches on the right side of the door and lock it.

Guidelines for the RX2102 and RX2104 Models

- The RX2102 and RX2104 models have a built-in solar panel to recharge the NiMH battery pack. Connect the solar panel cable to keep the battery charged. When mounting the station, position the solar panel in the direction where it will receive the most sunlight throughout the day and throughout each season. It may be necessary to periodically adjust the station position as the path of sunlight changes throughout the year or if the tree and leaf growth alters the amount of sunlight reaching the solar panel.
- If the location where you want to install the station does not produce enough sunlight to charge the battery, use an external solar panel (SOLAR-xW). Disconnect the built-in solar panel cable and tuck it in the station door. Plug in an external solar panel. Lightly coat the portion of the cable that will be placed in the cable channel with a small amount of silicone grease. Route the external solar panel cable through far-left hole in the cable channel.

Guidelines for the RX2103 and RX2104 Models

- The absolute pressure sensor in the water level sensor is temperature compensated over the range of 0° to 40°C (32° to 104°F). The barometric pressure sensor is temperature compensated over the range of -20° to 50°C (-4° to 122°F). To obtain the highest level of accuracy, both the sensor and station should be allowed to come to full temperature equilibrium (approximately 20 minutes) before the reference level is entered in HOBOLink as described in *Setting up the Station*.
- Sudden temperature changes should be avoided.
- When deploying the water level sensor in a well, make sure the well is vented to the atmosphere. Typically, a small hole can be drilled in the side of the well cap to ensure that the pressure inside and outside the well is at equilibrium. Use the Onset well cap (WELL-CAP-02) if it is a 5 cm (2 inch) well. Otherwise, you will need to find another method of attaching the cable at the top of your well so that the sensor stays in position. The sensor cable includes a Kevlar® strength member so it can support the weight of the sensor and its cable. You can attach a clamp around the cable, such as a hose clamp, but be careful not to damage the cable.
- There is a vent for the barometric sensor on the back of the station. This vent must not collect water or it will block proper barometric pressure readings. The best way to avoid water collecting is to mount the station vertically.

- The sensor face located in the nose cone of the sensor end needs to be in the water to measure water level.

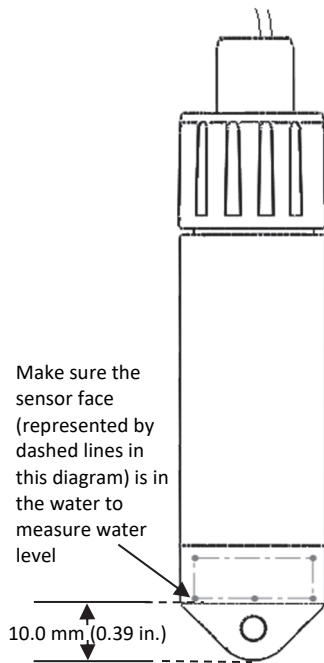

- Any change in length of the sensor cable will result in a 1-to-1 corresponding error in the depth measurement. Always pull-test a cable prior to deploying a logger in a well to make sure it does not stretch.
- If you are deploying the sensor in a lake, river, or stream, you must first build a stilling well to protect it and the cable. A simple stilling well can be constructed with PVC or ABS pipe. A properly constructed stilling well holds the sensor in position and protects the sensor from currents, wave action, and debris. Suspend the sensor in the stilling well so it is always underwater, but not on the bottom to be buried by silt.
For more information, see the Technical Application Note for Constructing a Stilling Well at: http://www.onsetcomp.com/water_level_stilling_well.html
- To prevent the sensor from moving in currents and to ensure the support cable is kept straight during deployment, you may need to add a weight to the suspension cable just above the sensor or hang a weight below the sensor. In some cases, you may need to both add a weight and use a stilling well.
- Be very careful not to exceed the burst pressure for the sensor. The pressure sensor will burst if the maximum depth is exceeded (see *Specifications*). The sensor should be positioned at a depth where it will remain in the water for the duration of the deployment, but not exceed the rated bursting depth.
- If the cable is too long, loop the cable and secure the cable with multiple zip ties to ensure the loop does not slip. The looped cable should be tight enough that the cable can be easily pulled out of the well if necessary, but it must not bend the cable any tighter than a 1.25 cm (0.5 inch) radius to prevent damage to the cable.

Installing the Grounding Wire

If you are using a grounding wire (CABLE-MICRO-G), attach it to the grounding wire port on the back of the station. Use the screw and washer included with the grounding wire to attach it to the port.

- If you are mounting the station on a tripod or mast, use the optional U-bolts (U-BOLT-KIT2). Attach the grounding wire under one of the nuts on one end of the U-bolt.
- If you are mounting the station on a metal post, clamp the grounding wire to the metal post with a hose clamp or a U-bolt.
- If you are mounting the station to a flat surface, attach the grounding wire to a proper ground. Note that the grounding wire may prevent the logger from being flat against the surface. Be careful not to bend the case when tightening screws.

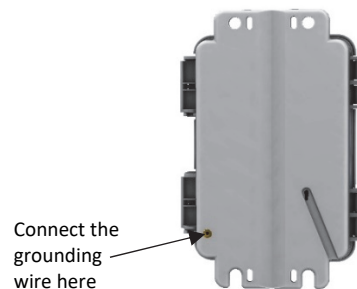

Care and Maintenance

The station is designed for outdoor use, but should be inspected periodically. When inspecting the station, do the following:

- Verify the station enclosure is free of visible damage or cracks.
- Make sure the station is clean. Wipe any dust or grime off with a damp cloth.
- For RX2102 and RX2104 models: Make sure the built-in solar panel is clean. Wipe off any debris with a damp cloth.
- Wipe any water off the station before opening it.
- Check that all cables and wires are free of damage, such as cracks, cuts, and splits.
- Make sure cables and wires are still fastened securely and any conduit is still intact.
- Grease the sides and bottom of the cable channel and the portion of the cables in the cable channel with a small amount of silicon grease.
- Verify that all cables and wires are free of corrosion. If moisture is visible inside the station, open the door to air it out. Be sure to determine the source of the moisture and fix it. Check the cable channel and cover seals for any sign of moisture entry.
- Make sure the cable channel is intact and installed properly, and the latches are fully locked when the station door is closed.

Troubleshooting

Error codes can appear on the LCD if a problem arises with the station or a sensor. This table describes common error codes that may appear. Contact Onset Technical Support for help.

Fault Code #	Description	Action to Take
001	System Failed Initialization	Power cycle the station (disconnect the battery and charging device, wait for a minute, and then plug the battery and charging device back in).
004	Sensor Error/Fault	Check the smart sensor data in HOBOLink to see which smart sensor is producing an error. You may need to remove or replace the smart sensor if the smart sensor is consistently reporting erroneous data.
129	Smart Sensor Bus Fault	There is a problem with one or more of the smart sensor connections. Check that all smart sensors are fully plugged in (follow the instructions in <i>Adding or Removing Smart Sensors</i>). Also check that the smart sensor cables are ok.

Battery Information for RX2101 and RX2103 Models

The RX2101 and RX2103 station requires 6 user-replaceable AA 1.5 V lithium batteries. You can also power the station with an AC adapter (P-AC-1) plugged into the AC adapter port. Expected battery life varies based on the ambient temperature where the station is deployed, the frequency of connections to HOBOLink, the number of sensors connected, the logging or sampling intervals selected, the number of tripped alarms, and other factors.

Battery life for the RX2101 model with a 1-minute logging interval is 1 year with daily connections to HOBOLink or 3 months with hourly connections. Battery life for the RX2103 model is 1 year with daily connections and a 2-minute logging interval or 2 months with hourly connections and a 1-minute logging interval. Deployments in areas with weak cellular strength could reduce battery life. Deployments in extremely cold or hot temperatures, logging intervals faster than 1 minute, or a sampling interval faster than 15 seconds can impact battery life. Estimates are not guaranteed due to uncertainties in initial battery conditions and operating environment.

⚠ WARNING: Do not cut open, incinerate, heat above 85°C (185°F), or recharge the lithium batteries. The batteries may explode if the logger is exposed to extreme heat or conditions that could damage or destroy the battery cases. Do not mix battery types, either by chemistry or age; batteries may rupture or explode. Do not dispose of the logger or batteries in fire. Do not expose the contents of the batteries to water. Dispose of the batteries according to local regulations for lithium batteries.

To replace the batteries:

1. Open the station door.
2. Disconnect the battery cable.

3. Use a flat-head screwdriver to remove the screw below the battery cover.

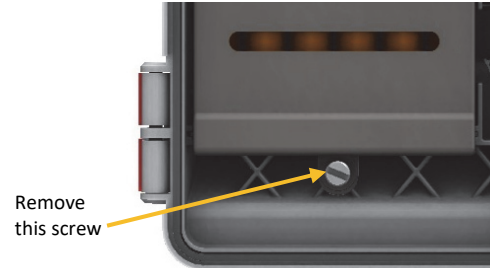

4. Pull to remove the battery cover.
5. Remove the old batteries.
6. Install six new batteries observing polarity.
7. Reinstall the battery cover.
8. Use a flat-head screwdriver to secure the cover with the screw.
9. Plug in the battery cable.

Battery Information for RX2102 and RX2104 Models

The RX2102 and RX2104 station uses one rechargeable NiMH battery pack (HRB-NiMH-6). Typical battery life is 3–5 years when operated in the temperature range -20° to 40°C (-4° to 104°F); operation outside this range will reduce the battery service life. Use the AC adapter (P-AC-1), built-in solar panel, or external solar panel (SOLAR-xW) to keep the battery charged. If using an external solar panel or built-in solar panel, the quality and quantity of solar light can affect whether the battery is sufficiently charged to last through the night and cloudy periods.

The maximum connection rates when using the built-in solar panel in full sun are:

- 10 minute connections year round for latitudes less than ±40°
- 10 minute connections through three seasons in other regions, reduced to 30 minute connections in winter

The maximum connection rate when using an external 5W or 15W solar panel is 10 minute connections year round, in full sun. The connection rate with external solar panels may be less if deployed in partial sun.

Battery life without solar recharging, with hourly connections, and a 1-minute logging interval is 3 months for the RX2102 model and 2 months for the RX2104 model.

Deployments in extremely cold or hot temperatures, a logging interval faster than 1 minute, or a sampling interval faster than 15 seconds can impact battery life. Estimates are not guaranteed due to uncertainties in initial battery conditions and operating environment. If using an external solar panel or built-in solar panel, the quality and quantity of solar light can affect whether the battery is sufficiently charged to last through the night and cloudy periods.

The station will shut down once the battery voltage drops to 6 V. Plug in an AC adapter or solar panel to recharge it. Once the voltage rises to 7.5 V, the station will power up. If the charging device is not recharging a dead battery, contact Onset Technical Support.

To replace the battery pack:

1. Open the station door.
2. Disconnect the battery cable.
3. Use a flat-head screwdriver to remove the screw below the battery cover.

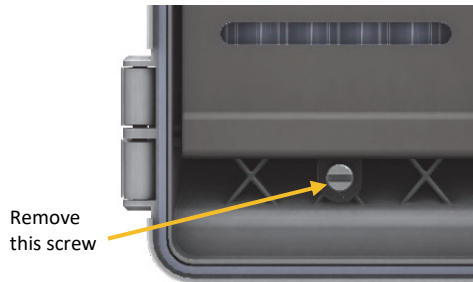

4. Pull to remove the battery cover.
5. Remove the old battery pack and install the new one from Onset.
6. Reinstall the battery cover.
7. Use a flat-head screwdriver to secure the cover with the screw.
8. Plug in the battery cable.
9. Make sure the built-in solar panel cable is plugged in. If you are using an external solar panel, make sure the built-in solar panel cable is tucked inside the station door. Plug in the external solar panel. Lightly coat the portion of the cable that will be placed in the cable channel with a small amount of silicone grease. Route the cable through the far-left hole in the cable channel.

⚠ WARNING: Dispose of the battery pack according to local regulations for NiMH batteries.

**Federal Communication Commission Interference Statement**

This equipment has been tested and found to comply with the limits for a Class B digital device, pursuant to Part 15 of the FCC Rules. These limits are designed to provide reasonable protection against harmful interference in a residential installation. This equipment generates uses and can radiate radio frequency energy and, if not installed and used in accordance with the instructions, may cause harmful interference to radio communications. However, there is no guarantee that interference will not occur in a particular installation. If this equipment does cause harmful interference to radio or television reception, which can be determined by turning the equipment off and on, the user is encouraged to try to correct the interference by one of the following measures:

- Reorient or relocate the receiving antenna
- Increase the separation between the equipment and receiver
- Connect the equipment into an outlet on a circuit different from that to which the receiver is connected
- Consult the dealer or an experienced radio/TV technician for help

This device complies with Part 15 of the FCC Rules. Operation is subject to the following two conditions: (1) This device may not cause harmful interference, and (2) this device must accept any interference received, including interference that may cause undesired operation.

FCC Caution: Any changes or modifications not expressly approved by the party responsible for compliance could void the user's authority to operate this equipment.

Industry Canada Statements

This device complies with Industry Canada license-exempt RSS standard(s). Operation is subject to the following two conditions: (1) this device may not cause interference, and (2) this device must accept any interference, including interference that may cause undesired operation of the device.

Avis de conformité pour l'Industrie Canada

Le présent appareil est conforme aux CNR d'Industrie Canada applicables aux appareils radio exempts de licence. L'exploitation est autorisée aux deux conditions suivantes : (1) l'appareil ne doit pas produire de brouillage, et (2) l'appareil doit accepter tout brouillage radioélectrique subi, même si le brouillage est susceptible d'en compromettre le fonctionnement.

To comply with FCC and Industry Canada RF radiation exposure limits for general population, the logger must be installed to provide a separation distance of at least 20cm from all persons and must not be co-located or operating in conjunction with any other antenna or transmitter.